

**Broil King®**

2023 Grilling Catalog





## Our Passion Lies Within Our People

**Our dedication to build the very best in quality performance grills reflects the exceptional team behind the brand.** Our story began in 1906, with a vision of quality and desire for excellence. With a focus on the grilling industry for the past 35 years, our brand family strives for performance, durability and creating great grilling experiences for our customers.

Our passion has always been to build lasting relationships with our customers by providing quality products backed with great service.

With manufacturing facilities in Huntington, Indiana; Dickson, Tennessee; and Waterloo, Ontario, we are able to design, manufacture and distribute North American-made grills in over 30 countries.

We are a family that loves to grill and it shows in every barbecue we build here in North America.

Our vision is plain and simple: **Great Barbecues Every Time.**

As Broil King® continues to be a family-owned and operated company, we hope that you are as proud to own a Broil King® as we are to make them.





# GET THE GRILL THAT'S MADE FOR FLAVOR



Broil King's premium cooking system is specifically designed with 3 layers of vaporization to maximize flavor so you can enjoy the best tasting grilling experience.





VAPORIZED JUICES • INFUSED BBQ FLAVOR



JUICES

VAPOR & FLAVOR

FLAV-R-CAST™ GRIDS

STAINLESS STEEL GRIDS

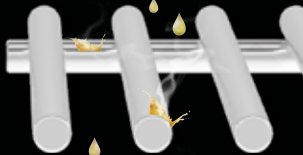

JUICES

VAPOR & FLAVOR

FLAV-R-WAVES™



ENCLOSED COOK BOX

JUICES

VAPOR & FLAVOR



MAXIMIZED FLAVOR

MINIMAL JUICES IN THE GREASE TRAY



## Thick and Durable Cookbox for Amazing Heat Retention

Made from die-cast aluminum and high-grade stainless steel, these durable cook boxes provide excellent heat retention and long lasting durability. The cookbox is designed to ensure even heat and heat retention for precise control.

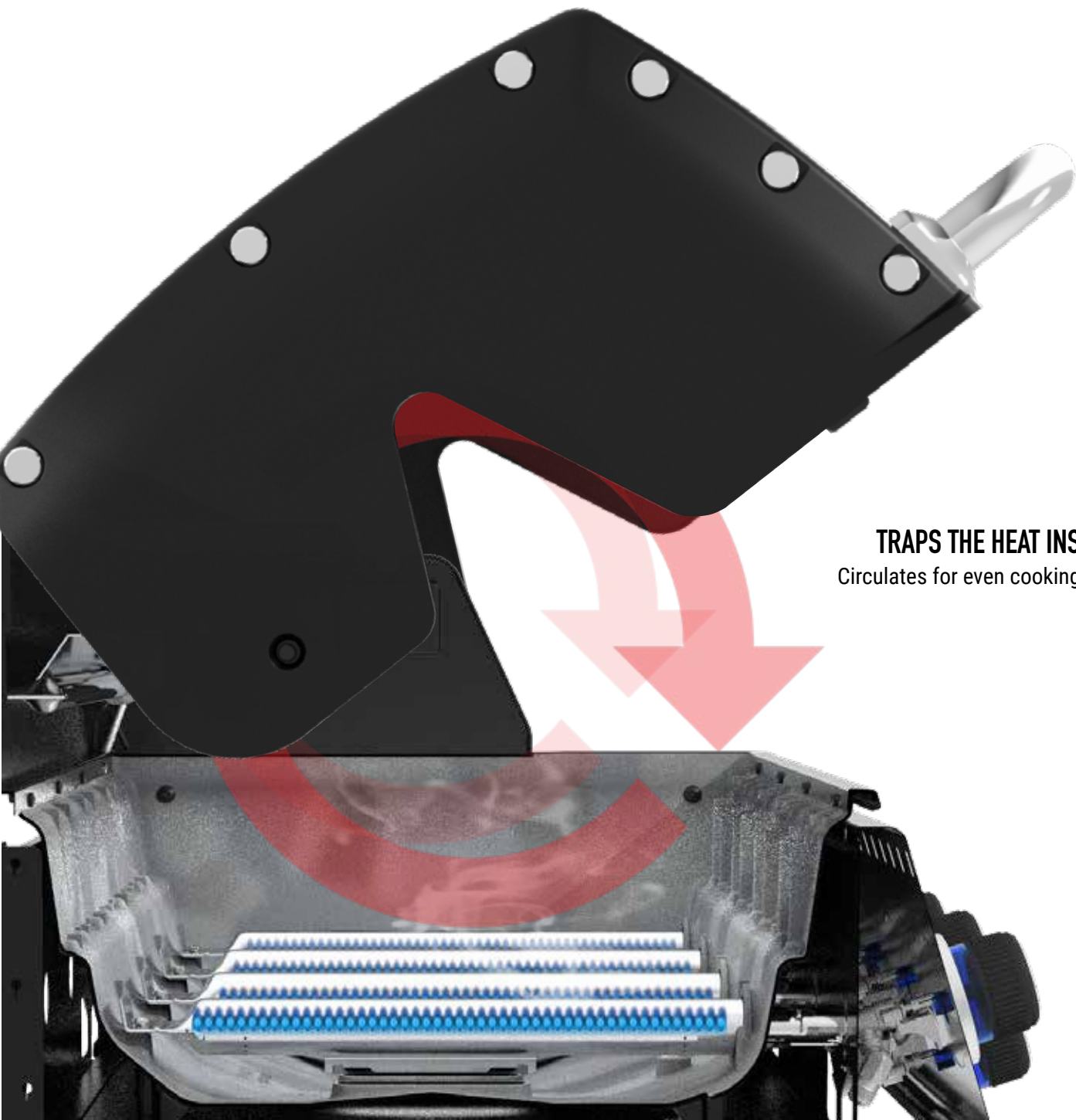

**TRAPS THE HEAT INSIDE**  
Circulates for even cooking results.







# Ultra-Premium Cast Stainless Steel Cooking Grids

You get the convenience of rust-resistant stainless steel with our renowned cast iron design. Standard on the Imperial™ series, meet the ultimate cooking grids that deliver excellent heat retention and exceptional searing power to lock in juices and flavor. These heavy Flav-R-Cast™ stainless grids have two sides: one side is pointed for those perfect steakhouse sear marks, while the other side has grooves for continuous basting.

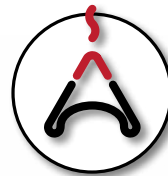
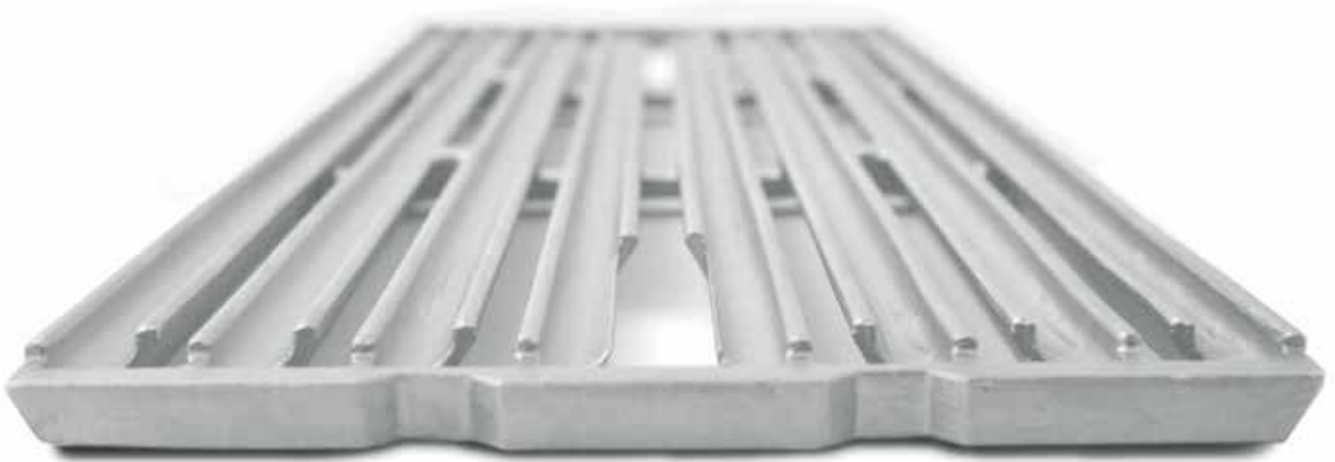

**POINTED SIDE**  
Steakhouse sear marks



**GROOVED SIDE**  
Bastes in flavor





# Professional-Grade Stainless Steel Cooking Grids

Standard on the Regal™ Pro and Baron™ Pro series, these premium cooking grids deliver excellent heat retention and exceptional searing power to lock in juices and flavor. Thick stainless steel rods are easy to clean and provide long lasting durability.

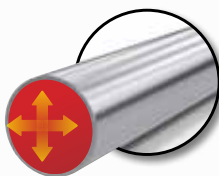

**REGAL™ PRO SERIES**  
9 mm Thick Rods

Exceptional  
Heat Retention

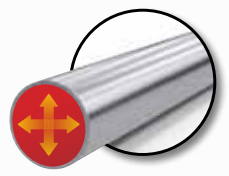

**BARON™ PRO SERIES**  
8 mm Thick Rods









## Heavy-Duty Cast Iron Cooking Grids

Standard on all Crown™, Signet™, Monarch™, Gem™, Porta-Chef™, Pellet and Smoke charcoal grills, these cooking grids deliver excellent heat retention and exceptional searing power to lock in juices and flavor. The heavy Flav-R-Cast™ iron grids have two sides: one side is pointed for those perfect steakhouse sear marks while the other side has grooves for continuous basting.

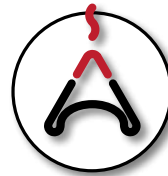

**POINTED SIDE**  
Steakhouse sear marks



**GROOVED SIDE**  
Bastes in flavor







**NOW YOU CAN ANGLE  
YOUR COOKING GRIDS**

Channels excess juices to the  
grease tray to avoid flare-ups

**ONLY AVAILABLE ON THE  
ALL-NEW CROWN™ SERIES**



# The Flav-R-Wave™ Cooking System Infuses Great Flavor into Your Food

The stainless steel Flav-R-Wave™ cooking system provides superior heat distribution across the entire surface of the grill while protecting the burners. Drippings that fall onto the Flav-R-Wave™ are instantly vaporized. Vapor created through this process infuses into your food for unmistakable barbecue flavor.

## **GREAT BARBECUE FLAVOR**

Vaporized juices infuse into your food



## **EVEN HEAT DISTRIBUTION**

Covers the entire cookbox area

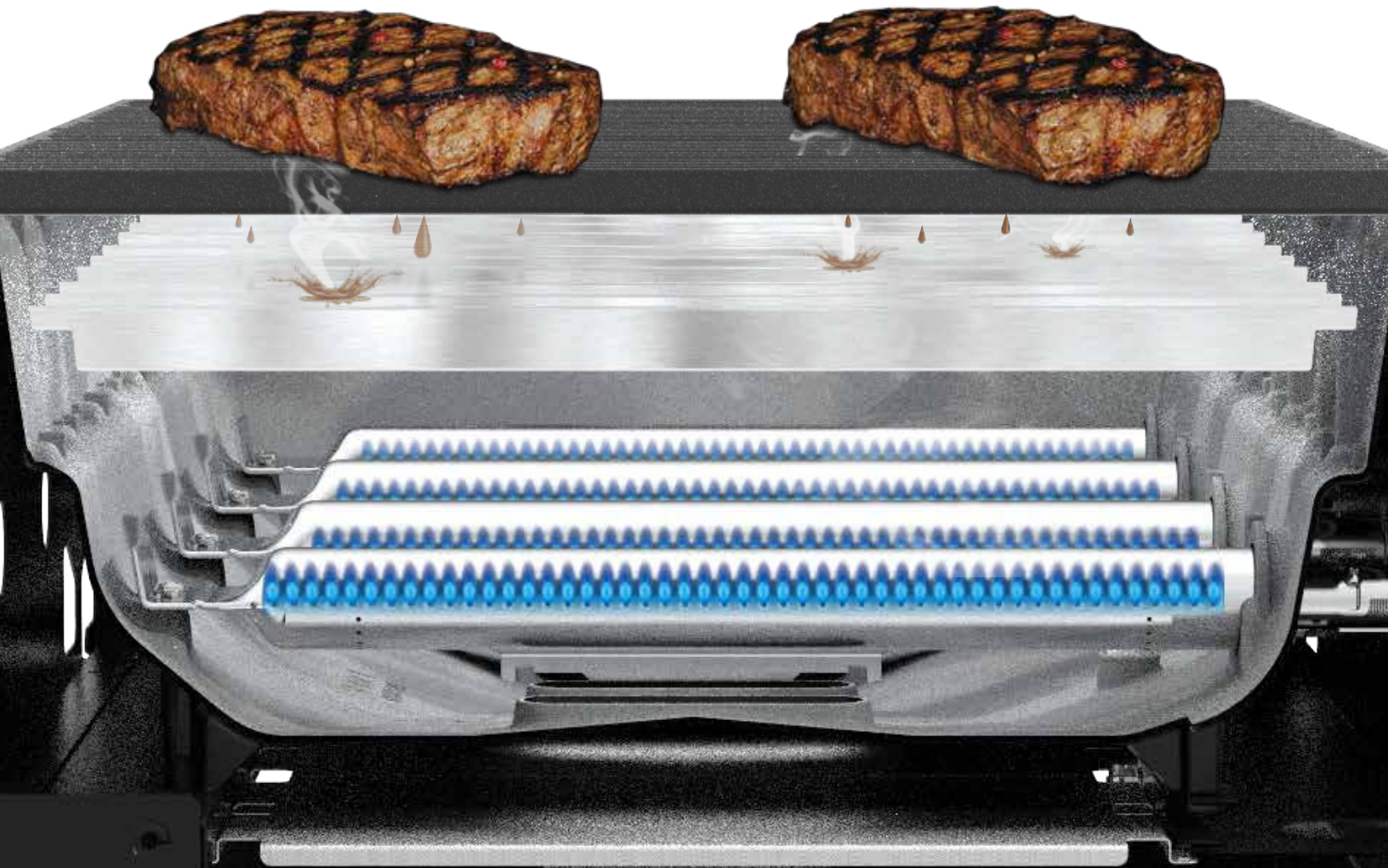







## Patented Dual-Tube™ Burners Means Twice the Flame for Twice the Performance

Broil King's patented Dual-Tube™ burners are made from high quality, heavy-duty stainless steel. These large diameter, tube-in-tube side-ported burners provide even heat distribution (front to back and side to side) with two rows of flame per burner.

### 2 ROWS OF FLAME PER BURNER

Even heat ~ front to back and side to side

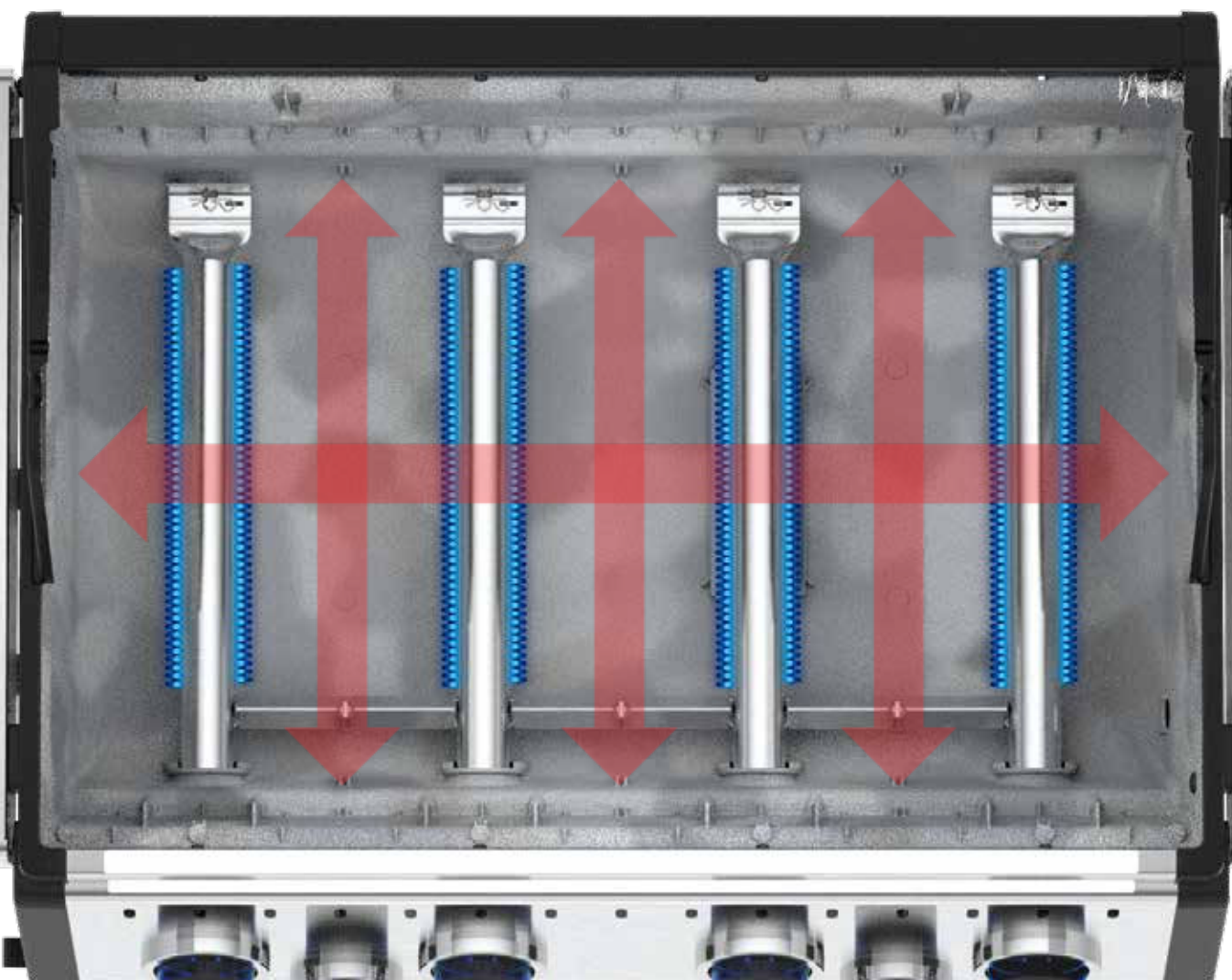





## 180 Degrees of Temperature Control for Perfect Grilling Results

Linear-Flow™ valves with 180 degree control knobs give you infinite heat control allowing you to set your grill to the perfect temperature for searing, roasting, or slow cooking.

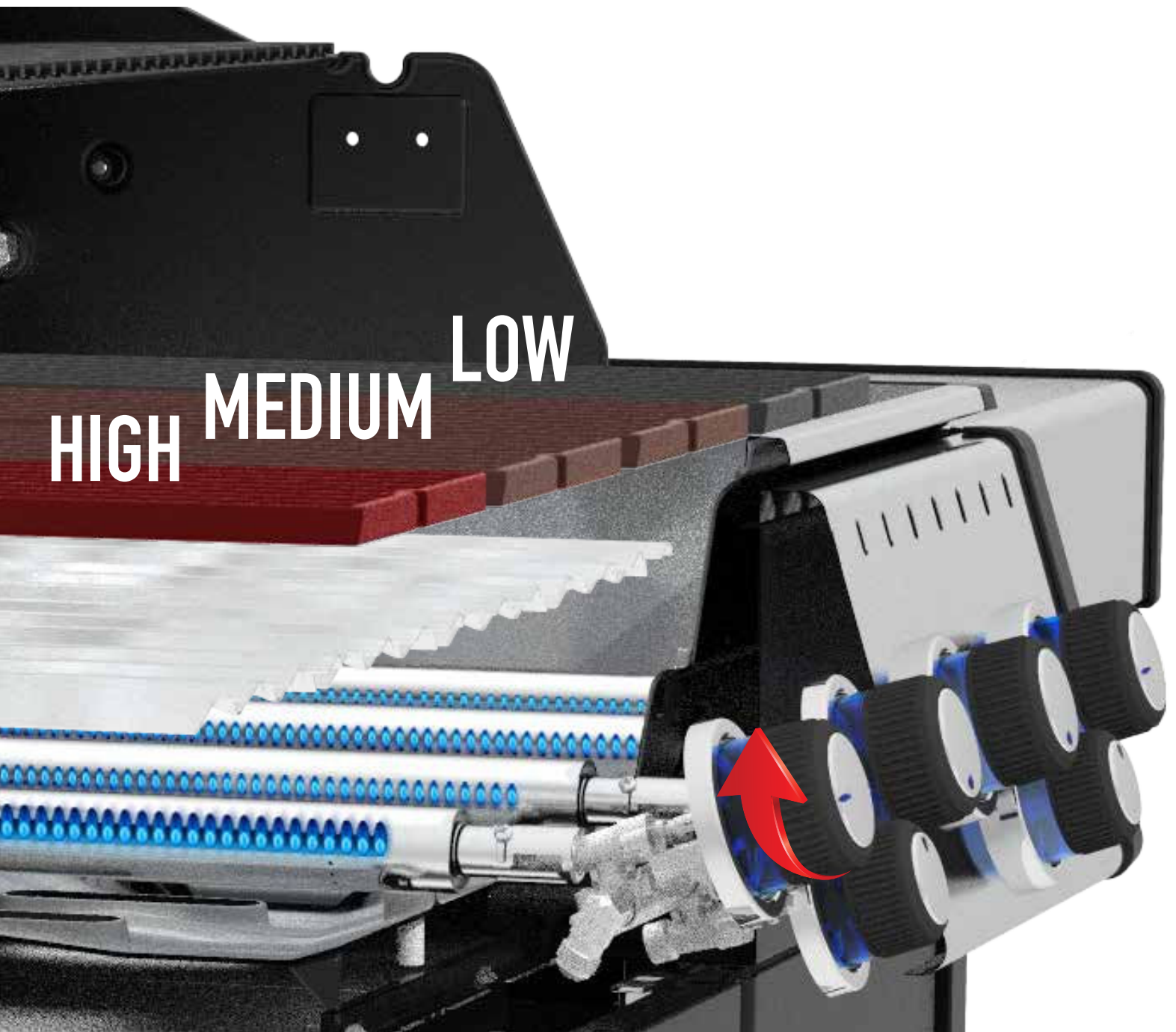









# IMPERIAL™

**Finally a smarter choice for grilling centers.** Broil King® gives you a new level of flexibility with the unique modular pod system. Broil King's Imperial™ series is a match of performance and luxury designed for the professional outdoor chef. These premium grills come equipped with standout features like commercial-grade cast stainless steel cooking grids, a double-wall stainless steel cookbox and patented stainless steel Dual-Tube™ burners. Crafted with durable North American 304 grade stainless steel, the exterior is inspired by professional cooking appliances. Light up the night with back-lit control knobs and oven lights to instantly create the perfect ambiance at your next get-together.







### Imperial™ S 690i Island

60,000 BTU Main Burner Output

6 Dual-Tube™ Burners

Stainless Steel Cast Grids

15,000 BTU Rotisserie Burner

10,000 BTU commercial-grade side burner



### Imperial™ S 690

### Imperial™ S 690 Built-in

60,000 BTU Main Burner Output

6 Dual-Tube™ Burners

Stainless Steel Cast Grids

15,000 BTU Rotisserie Burner

10,000 BTU commercial-grade side burner



### Imperial™ S 590i Island

55,000 BTU Main Burner Output

5 Dual-Tube™ Burners

Stainless Steel Cast Grids

15,000 BTU Rotisserie Burner

10,000 BTU commercial-grade side burner



### Imperial™ S 590



### Imperial™ S 590 Built-in

55,000 BTU Main Burner Output

5 Dual-Tube™ Burners

Stainless Steel Cast Grids

15,000 BTU Rotisserie Burner

10,000 BTU commercial-grade side burner





### Imperial™ S 490



### Imperial™ S 490 Built-in

44,000 BTU Main Burner Output

4 Dual-Tube™ Burners

Stainless Steel Cast Grids

15,000 BTU Rotisserie Burner

10,000 BTU commercial-grade side burner



### Regal™ S 420



### Regal™ S 420 Built-in

44,000 BTU Main Burner Output

4 Dual-Tube™ Burners

9 mm Stainless Steel Grids



Regal™ S 520



### Regal™ S 520 Built-in

55,000 BTU Main Burner Output

5 Dual-Tube™ Burners

9 mm Stainless Steel Grids

## BUILT-IN ASSEMBLY HOW IT WORKS

### Easy to assemble. Better to enjoy.

Simply choose your grill, burner, cabinets, outdoor kitchen accessories and countertop and you're on your way to creating your ultimate outdoor grilling center. The stainless steel cabinets come pre-assembled so all that is required is securing them together with a few fasteners.



Lift the cabinet onto the L-Bracket affixed to the adjoining bottom cabinet.





### Imperial™ S 200 Range Burner



### Imperial™ S 200 Range Burner

20,000 BTU Range Burner

2 range burners each with individual controls

Two durable cast iron trivets

[View Specs](#)



### 6 Burner Stainless Steel Cabinet

Premium 304 grade stainless steel

Four sturdy leveling feet

Four stainless steel drawers

34.45-in x 45.2-in x 29.84-in



### Imperial™ S 100 Range Burner



### Imperial™ S 100 Range Burner

11,000 BTU Range Burner

Range burner with individual control

Durable cast iron trivet

[View Specs](#)



### 5 Burner Stainless Steel Cabinet

Premium 304 grade stainless steel

Four sturdy leveling feet

Four stainless steel drawers

34.45-in x 37.88-in x 29.84-in





## 4 Burner Stainless Steel Cabinet

Premium 304 grade stainless steel

Four sturdy leveling feet

Two stainless steel drawers

34.45-in x 31.5-in x 29.84-in



## Imperial™ S 200 Range Burner Cabinet

Premium 304 grade stainless steel

Four sturdy leveling feet

Three stainless steel easy-glide drawers

34.45-in x 17.72-in x 29.84-in



\*Sink and countertop not included.

## 2 Door Stainless Steel Cabinet

Premium 304 grade stainless steel

Four sturdy leveling feet

Two stainless steel doors with stainless steel shelf

34.45-in x 35.41-in x .35.41-in



\*Countertop and side burner not included.

## Tank/Side Burner Stainless Steel Cabinet

Premium 304 grade stainless steel

Four sturdy leveling feet

Stainless steel door with pull-out propane tank drawer

34.45-in x 17.72-in x 29.84-in





### 3 Drawer Stainless Steel Cabinet

Premium 304 grade stainless steel

Four sturdy leveling feet

Three stainless steel easy-glide drawers

34.45-in x 17.72-in x 29.84-in



### Waste Organizer Stainless Steel Cabinet

Premium 304 grade stainless steel

Stainless steel door / pull-out cabinet

White trash bin and blue recycling bin included

34.45-in x 17.72-in x 29.84-in



### 1 Door/Drawer Stainless Steel Cabinet

Premium 304 grade stainless steel

Four sturdy leveling feet

Stainless steel door with shelf / one easy-glide drawer

34.45-in x 17.72-in x 29.84-in

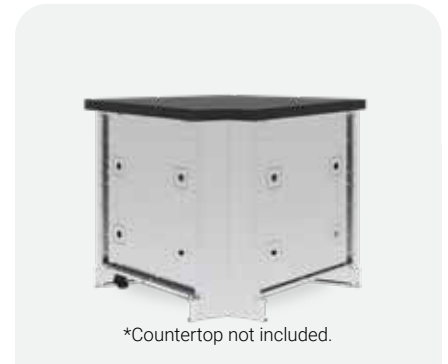

### 90° Corner Cabinet

Premium 304 grade stainless steel

Six sturdy leveling feet

34.8-in x 27.06-in x 27.3-in





### Door Assembly – Double

Premium 304 grade stainless steel

---

2 stainless steel doors

---

Stainless steel trim

---

28.5-in x 39.25-in x 4.50-in

72.39 cm x 99.7 cm x 11.43 cm



### Door Assembly – Single

Premium 304 grade stainless steel

---

Stainless steel door

---

Stainless steel trim

---

28.5-in x 21.75-in x 4.50-in

72.39 cm x 55.25 cm x 11.43 cm





\*Countertop and rear panel not included.

## 24-IN Outdoor Refrigerator

Cutting-edge temperature management system with door ajar alarm

Temperature Range: Low: 36°F / High: 50°F | Low: 2.2°C / High: 10°C

Capacity volume of 155 Liters / 5.5 cu. ft

Smudge-resistant stainless steel

36.38-in x 23.82-in x 25.87-in



| Cabinet Panels                  | Cabinet panels are constructed from premium 304 stainless steel          |
|---------------------------------|--|
| Cabinet Side Panel              | 30.69-in x 1.97-in x 29.53-in  |
| Rear Panel – 6 Burner Cabinet   | 30.69-in x 45.2-in x 1.85-in   |
| Rear Panel – 5 Burner Cabinet   | 30.69-in x 37.88-in x 1.85-in  |
| Rear Panel – 4 Burner Cabinet   | 30.69-in x 31.5-in x 1.85-in   |
| Rear Panel – 2 Door Cabinet     | 30.69-in x 35.41-in x 1.85-in  |
| Rear Panel – Small Cabinet      | 30.69-in x 17.72-in x 1.85-in  |
| Rear Panel – 90° Corner Cabinet | 2 Pieces   30.69-in x 17.72-in x 1.85-in                                 |
| 24-in Compact Fridge Back Panel | Fits most 24-in wide compact refrigerators   30.69-in x 24.02-in x 28.43 |
| 22-in Compact Fridge Back Panel | Fits most 22-in wide compact refrigerators   30.69-in x 22.05-in x 28.43 |



## BUILT-IN ASSEMBLY HOW IT WORKS

**Easy to assemble. Better to enjoy.**

Simply choose your grill, burner, cabinets, outdoor kitchen accessories and countertop and you're on your way to creating your ultimate outdoor grilling center. The stainless steel cabinets come pre-assembled so all that is required is securing them together with a few fasteners.

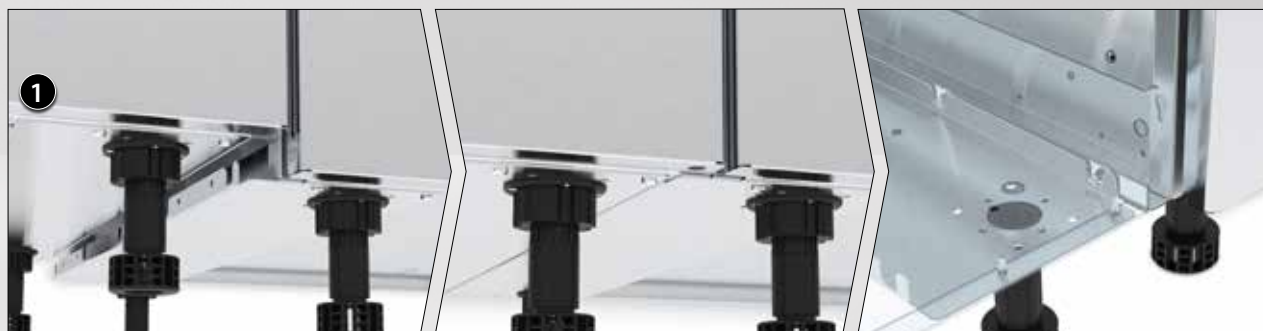

Lift the cabinet onto the L-Bracket affixed to the adjoining bottom cabinet.



**BROIL KING® IMPERIAL™ 590 BUILT-IN**

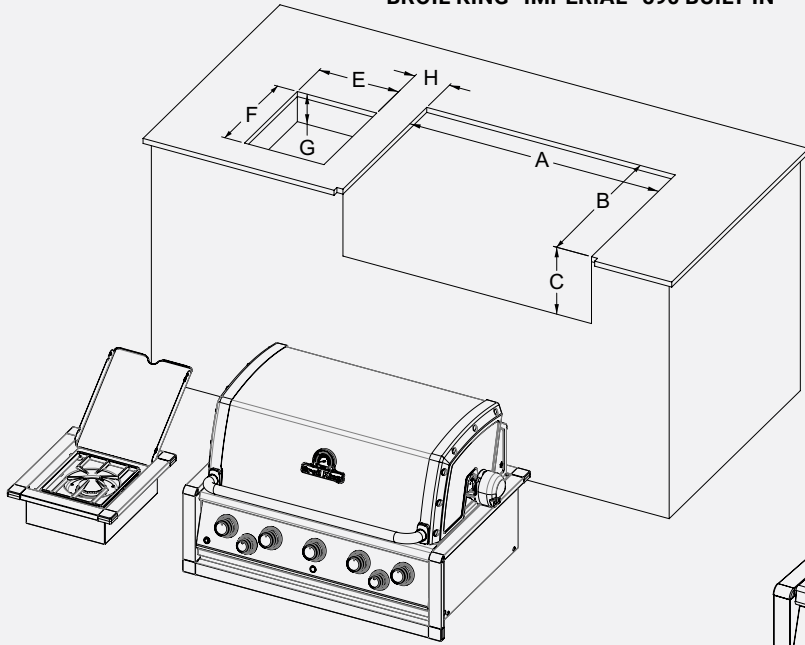

**BROIL KING® IMPERIAL™ S 200 RANGE BURNER**

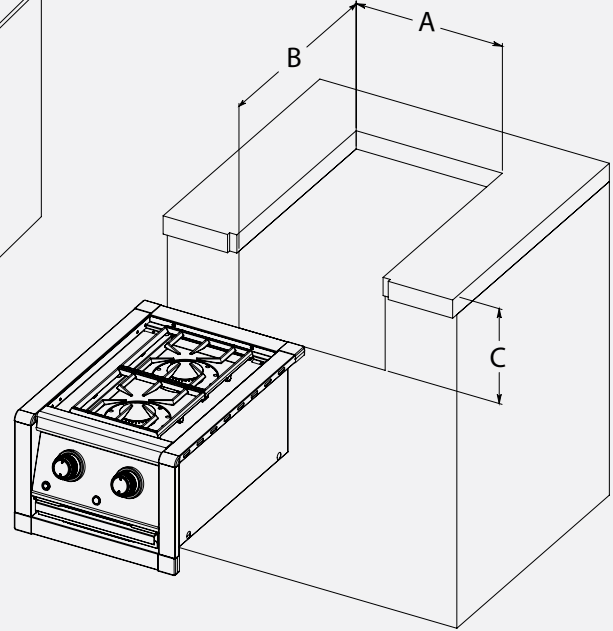

**COUNTER TOP NOTCH DETAIL**

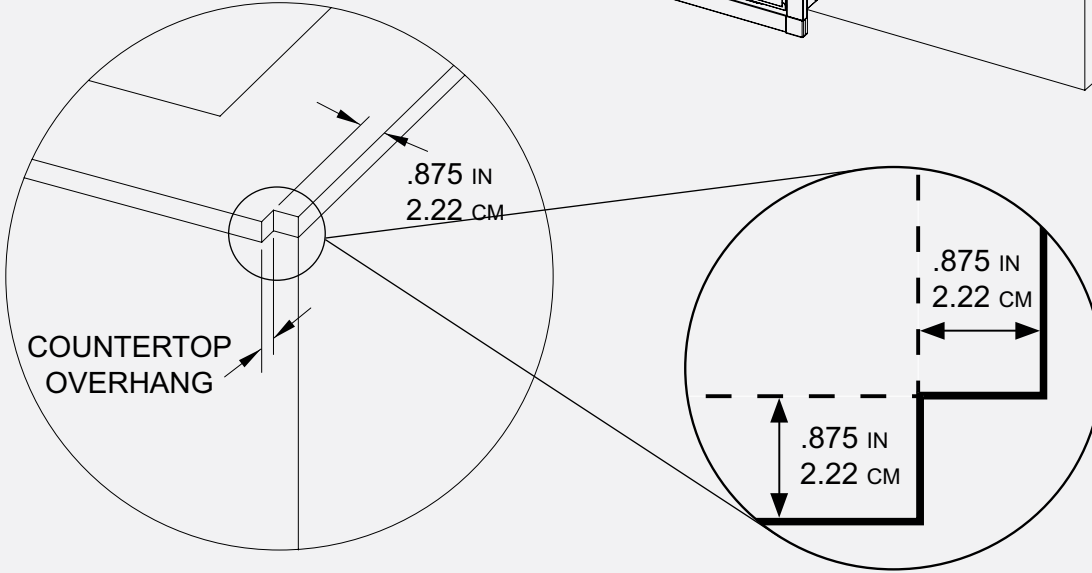

**ISLAND CUT-OUT DIMENSIONS**

|          | BROIL KING® IMPERIAL™ 600 | IMPERIAL™ / REGAL™ 500                           | IMPERIAL™ / REGAL™ 400 | IMPERIAL™ S 200 RANGE BURNER | TOLERANCE          |
|----------|---------------------------|--|------------------------|------------------------------|--------------------|
| <b>A</b> | 43.625 IN   110.80 CM     | 36.25 IN   92.00 CM                              | 29.78 IN   75.80 CM    | 16.25 IN   41.20 CM          | +0.25 IN   0.70 CM |
| <b>B</b> |                           | 23.125 IN   59.00 CM                             |                        | 23.125 IN   59.00 CM         | +0.22 IN   0.50 CM |
| <b>C</b> |                           | 10.90 IN   28.00 CM                              |                        | 10.90 IN   28.00 CM          | +0.22 IN   0.50 CM |
| <b>D</b> |                           | 31.50 IN   80.00 CM                              |                        |                              | +0.39 IN   1.00 CM |
| <b>E</b> |                           | 11.50 IN   29.00 CM                              |                        |                              | +0.39 IN   1.00 CM |
| <b>F</b> |                           | 14.50 IN   37.00 CM                              |                        |                              |                    |
| <b>G</b> |                           | MIN. 4.50 IN   11.43 CM                          |                        |                              |                    |
| <b>H</b> |                           | MIN. 4.50 IN   7.62 CM – MAX. 7.00 IN   18.00 CM |                        |                              |                    |
| <b>I</b> |                           | MIN. 34.00 IN   86.50 CM                         |                        |                              |                    |

# The Imperial™ Series | Grilling Area



**Imperial™ S 600 | 1,030 Square Inches Total Grilling Area**

**Large Stainless Warming Rack**  
210 Square Inches



**Small Rack**  
70 Sq In



**Large Cookbox**  
Cast Stainless Grids - 500 Sq In

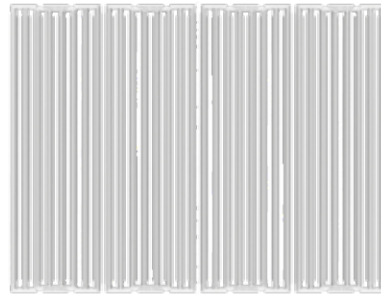

**Small Cookbox**  
250 Sq In



**Imperial™ S 500 | 875 Square Inches Total Grilling Area**

**Stainless Warming Rack**  
250 Square Inches



**Cookbox**  
Cast Stainless Grids - 625 Sq In



**Imperial™ S 400 | 695 Square Inches Total Grilling Area**

**Stainless Warming Rack**  
195 Square Inches



**Cookbox**  
Cast Stainless Grids - 500 Sq In

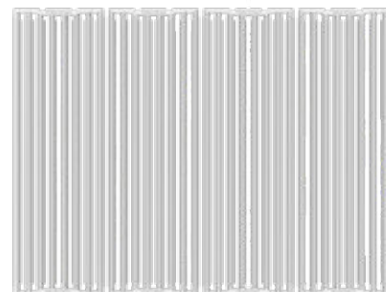



# The Imperial™ Series | Features

Cast Stainless Steel Grids



Cast Iron Sider Burner



Stainless Steel Rotisserie Burner



Patented Dual-Tube™ Burners



Stainless Steel Cookbox



Stainless Steel Warming Rack



LED Control Lights



Built-in Oven Lights



Stainless Steel Flav-R-Wave™



Stainless Steel Handles



Slide-Out Grease Tray System



Electronic Ignition



# The Regal™ Series | Grilling Area



**Regal™ S 520 | 875 Square Inches Total Grilling Area**

**Stainless Warming Rack**  
250 Square Inches



**Cookbox**  
Stainless Grids - 625 Sq In

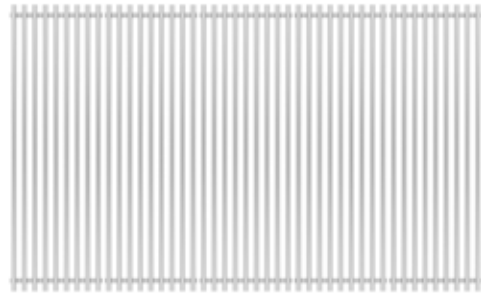

**Regal™ S 420 | 695 Square Inches Total Grilling Area**

**Stainless Warming Rack**  
195 Square Inches



**Cookbox**  
Stainless Grids - 500 Sq In

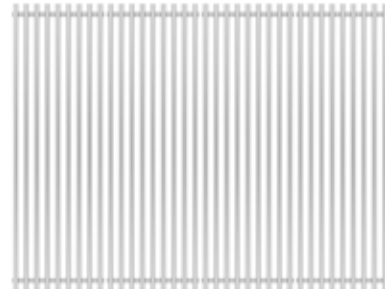



# The Regal™ Series | Features

Stainless Steel Grids



Stainless Steel Cookbox



Stainless Steel Warming Rack



Patented Dual-Tube™ Burners



Stainless Steel Flav-R-Wave™



Electronic Ignition



LED Control Lights



Slide-Out Grease Tray System



Stainless Steel Handles









# REGAL™

**Family entertainment is what Broil King® is all about.** The enhanced Regal™ series is designed to help you create mouthwatering dishes that will surely be the hit of the party. Features that have made us an industry leader are apparent, from the moment you see the fit and finish to when you experience the outstanding grilling performance. For the outdoor chef who lives to entertain: welcome to the Broil King® Regal™ series.





### Regal™ S 690 Pro IR

60,000 BTU Main Burner Output

6 Dual-Tube™ Burners

9 mm Stainless Steel Grids

15,000 BTU Rotisserie Burner

10,000 BTU Infrared Side Burner



### Regal™ S 590 Pro IR

55,000 BTU Main Burner Output

5 Dual-Tube™ Burners

9 mm Stainless Steel Grids

15,000 BTU Rotisserie Burner

10,000 BTU Infrared Side Burner



### Regal™ S 420 Pro

50,000 BTU Main Burner Output

4 Dual-Tube™ Burners

9 mm Stainless Steel Grids





### Regal™ S 590 Pro

55,000 BTU Main Burner Output

5 Dual-Tube™ Burners

9 mm Stainless Steel Grids

15,000 BTU Rotisserie Burner

10,000 BTU Cast Side Burner



### Regal™ S 490 Pro IR

50,000 BTU Main Burner Output

4 Dual-Tube™ Burners

9 mm Stainless Steel Grids

15,000 BTU Rotisserie Burner

10,000 BTU Infrared Side Burner



# The Regal™ Series | Grilling Area



**Regal™ S 690 Pro | 1,150 Square Inches Total Grilling Area**

**Large Stainless Warming Rack**  
210 Square Inches



**Small Rack**  
70 Sq In

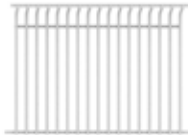

**IR Grid**  
120 Sq In



**Large Cookbox**  
Stainless Grids - 500 Sq In

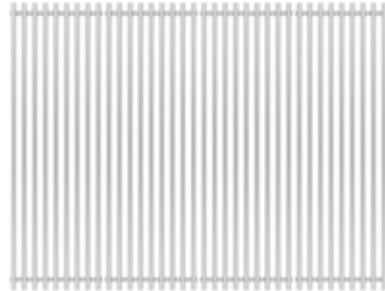

**Small Cookbox**  
250 Sq In



**Regal™ S 500 Pro | 995 / 875 Square Inches Total Grilling Area**

**Stainless Warming Rack**  
250 Square Inches



**IR Grid**  
120 Sq In



**Cookbox**  
Stainless Grids - 625 Sq In



**Regal™ S 400 Pro | 815 / 695 Square Inches Total Grilling Area**

**Stainless Warming Rack**  
195 Square Inches



**IR Grid**  
120 Sq In



**Cookbox**  
Stainless Grids - 500 Sq In





# The Regal™ Series | Features

Stainless Steel Grids



Infrared Side Burner



Stainless Steel Rotisserie Burner



Cast Iron Side Burner



Stainless Steel Cookbox



Stainless Steel Warming Rack



Stainless Steel Handles



Electronic Ignition



LED Control Lights



Pull-Out Tank Drawer



Side Shelf Bins and Tool Hooks



Durable Resin Locking Casters







# BARON™

**The Broil King® Baron™ Pro series is the perfect addition to any household.** These grills come equipped with a rust-resistant, Limited Lifetime Warranty Therma-Cast™ cookbox, professional-grade stainless steel cooking grids and warming rack, a powerful infrared side burner and convenient rotisserie burner. Other added features include fold-down, locking side shelves; a unique grease management system and attractive LED control knob lights. These grills are designed for the ultimate grilling experience.







### Baron™ S 590 Pro IR

45,000 BTU Main Burner Output

5 Dual-Tube™ Burners

8 mm Stainless Steel Grids

15,000 BTU Rotisserie Burner

10,000 BTU Infrared Side Burner



### Baron™ 590 Pro

45,000 BTU Main Burner Output

5 Dual-Tube™ Burners

8 mm Stainless Steel Grids

15,000 BTU Rotisserie Burner

10,000 BTU Cast Side Burner



### Baron™ 490 Pro

40,000 BTU Main Burner Output

4 Dual-Tube™ Burners

8 mm Stainless Steel Grids

15,000 BTU Rotisserie Burner

10,000 BTU Cast Side Burner



### Baron™ 440 Pro IR

40,000 BTU Main Burner Output

4 Dual-Tube™ Burners

8 mm Stainless Steel Grids

10,000 BTU Infrared Side Burner





---

### Baron™ 520 Pro

45,000 BTU Main Burner Output

---

5 Dual-Tube™ Burners

---

8 mm Stainless Steel Grids



---

### Baron™ S 490 Pro IR

40,000 BTU Main Burner Output

---

4 Dual-Tube™ Burners

---

8 mm Stainless Steel Grids

---

15,000 BTU Rotisserie Burner

---

10,000 BTU Infrared Side Burner



---

### Baron™ 440 Pro

40,000 BTU Main Burner Output

---

4 Dual-Tube™ Burners

---

8 mm Stainless Steel Grids

---

10,000 BTU Cast Side Burner



---

### Baron™ 420 Pro

40,000 BTU Main Burner Output

---

4 Dual-Tube™ Burners

---

8 mm Stainless Steel Grids



## Baron™ 320 Pro

30,000 BTU Main Burner Output

3 Dual-Tube™ Burners

8 mm Stainless Steel Grids









# The Baron™ Series | Grilling Area



**Baron™ 500 Pro | 900 / 780 Square Inches Total Grilling Area**

**Stainless Warming Rack**  
210 Square Inches



**IR Grid**  
120 Sq In



**Cookbox**  
Stainless Grids - 570 Sq In

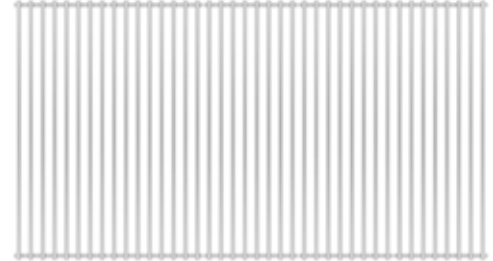

**Baron™ 400 Pro | 750 / 630 Square Inches Total Grilling Area**

**Stainless Warming Rack**  
170 Square Inches



**IR Grid**  
120 Sq In



**Cookbox**  
Stainless Grids - 460 Sq In

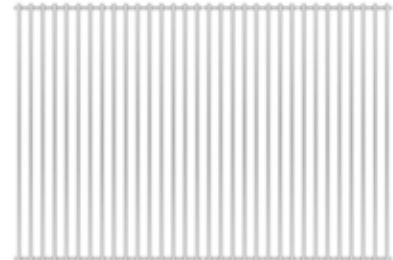

**Baron™ 320 Pro | 470 Square Inches Total Grilling Area**

**Stainless Warming Rack**  
120 Square Inches



**Cookbox**  
Stainless Grids - 350 Sq In

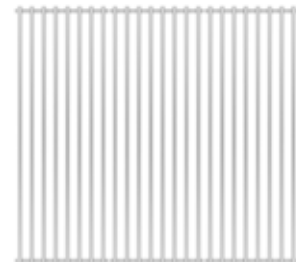

# The Baron™ Series | Features

Stainless Steel Grids



Infrared Side Burner



Stainless Steel Rotisserie Burner



Cast Iron Side Burner



Therma Cast™ Aluminum Cookbox

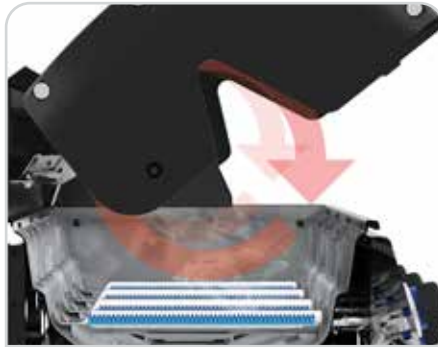

Stainless Steel Warming Rack



Durable Locking Casters



Grease Management System



Tank Holder



Fold-Down Locking Shelves



LED Control Lights



Electronic Ignition









# CROWN™

---

**Designed for performance, versatility and great value.** The Crown™ series offers performance and versatility with a contemporary look. Broil King's cooking system features heavy cast iron cooking grids to sear the perfect steak. They can also be angled to channel excess juices away and avoid any flare-ups. The stainless steel Flav-R-Wave™ vaporizes juices and infuses them back into your food for great flavor. Powerful side-ported dual-flame tube burners provide twice the amount of heat per burner. The versatile Crown™ series is designed for performance and great value.





### Crown™ S 490

40,000 BTU Main Burner Output

4 Dual-Tube™ Burners

Cast Iron Cooking Grids

15,000 BTU Rotisserie Burner

10,000 BTU Stainless Side Burner



### Crown™ S 440

40,000 BTU Main Burner Output

4 Dual-Tube™ Burners

Cast Iron Cooking Grids

10,000 BTU Stainless Side Burner



### Crown™ 410

40,000 BTU Main Burner Output

4 Dual-Tube™ Burners

Cast Iron Cooking Grids



### Crown™ 310

30,000 BTU Main Burner Output

3 Dual-Tube™ Burners

Cast Iron Cooking Grids

[View Specs](#)

[View Specs](#)





**Crown™ 420**

40,000 BTU Main Burner Output

4 Dual-Tube™ Burners

Cast Iron Cooking Grids

The Crown™  
cookbox  
allows you  
to *angle*  
your  
cooking  
grids

Channels excess juices  
to the grease tray to  
avoid flare-ups



# The Crown™ Series | Grilling Area



Crown™ 400 | 630 Square Inches Total Grilling Area

Porcelain-Coated Steel Warming Rack  
170 Square Inches



Cookbox  
Cast Iron Grids - 460 Sq In

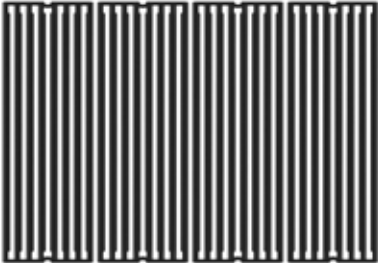



# The Crown™ Series | Features

Heavy-Duty Cast Iron Grids



Stainless Steel Side Burner



Stainless Steel Rotisserie Burner



Therma Cast™ Aluminum Cookbox

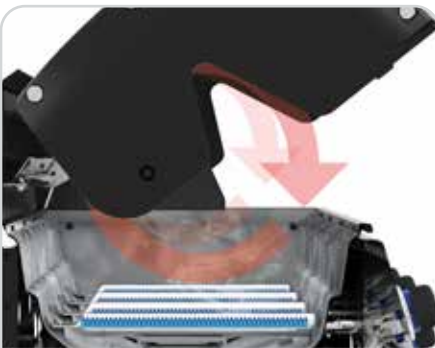

Stainless Steel Handles



Tool Hooks



Durable Locking Casters



Grease Management System



Tank Holder



Fold-Down Locking Shelves



180 Degree Control



Electronic Ignition









# Oil King®

*"It has to be great quality. I need to create the best experience for my guests at my restaurant or on my patio at home."* Paul Boehmer







# SIGNET™

---

**A true classic that stands the test of time.** The refined Broil King® Signet™ is one of our most popular gas grills. It offers 635 square inches of total cooking space and heavy-duty cast iron cooking grids. With three stainless steel Dual-Tube™ burners, you can cook a variety of foods at the same time. The Therma-Cast™ aluminum oven retains heat for convection cooking large roasts - even your holiday turkey. The Broil King® Signet™ series is trusted by grilling enthusiasts around the world for great results and great barbecues every time.





### Signet™ 390

40,000 BTU Main Burner Output

3 Dual-Tube™ Burners

Heavy-Duty Cast Iron Grids

15,000 BTU Rotisserie Burner

10,000 BTU Stainless Side Burner

### Signet™ 320

40,000 BTU Main Burner Output

3 Dual-Tube™ Burners

Heavy-Duty Cast Iron Grids

## The Signet™ Series | Grilling Area



Signet™ 300 | 635 Square Inches Total Grilling Area

Stainless Warming Rack  
235 Square Inches



Cookbox  
Cast Iron Grids - 400 Sq In

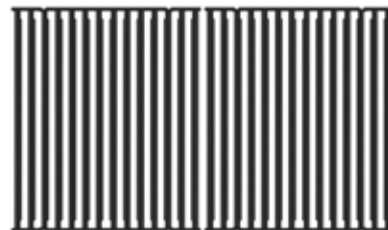



# The Signet™ Series | Features

Heavy-Duty Cast Iron Grids



Stainless Steel Side Burner



Stainless Steel Rotisserie Burner



Therma Cast™ Aluminum Cookbox

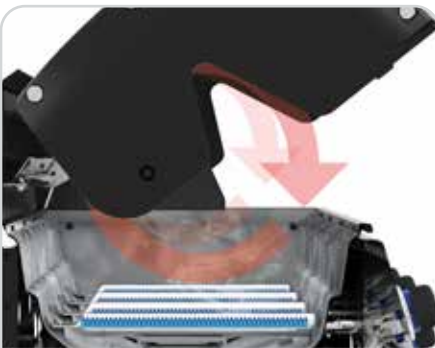

Stainless Steel Side Shelves



Tool Hooks



Durable Resin Wheels and Casters



Slide-Out Drip Tray



Tank Holder



Fold-Down Shelves



180 Degree Control



Electronic Ignition









# MONARCH™

---

**High performance grilling comes in all sizes.** The compact Broil King® Monarch™ series is designed for smaller spaces on your deck or patio. Don't let the size fool you; this grill has Broil King®'s legendary PGT cooking system to deliver exceptional results. Each grill features a rust-proof cast aluminum cookbox and powerful Dual-Tube™ burners. All Monarch™ grills come equipped with stylish fold-down side shelves with integrated tool hooks and a door designed for easy access to a propane tank. These quality, stylish grills are made for performance and dependability.





**Monarch™ 390**

40,000 BTU Main Burner Output

3 Dual-Tube™ Burners

Heavy-Duty Cast Iron Grids

15,000 BTU Rotisserie Burner

10,000 BTU Stainless Side Burner



**Monarch™ 340**

40,000 BTU Main Burner Output

3 Dual-Tube™ Burners

Heavy-Duty Cast Iron Grids

10,000 BTU Stainless Side Burner



**Monarch™ 320**

40,000 BTU Main Burner Output

3 Dual-Tube™ Burners

Heavy-Duty Cast Iron Grids

**The Monarch™ Series  
Grilling Area**



**520 Square Inches  
Total Grilling Area**

Stainless Warming Rack  
170 Square Inches



Cookbox  
Cast Iron Grids - 350 Sq In

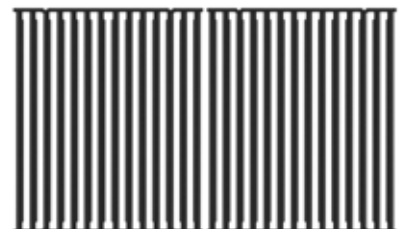



# The Monarch™ Series | Features

Heavy-Duty Cast Iron Grids



Stainless Steel Side Burner



Stainless Steel Handles



Therma Cast™ Aluminum Cookbox

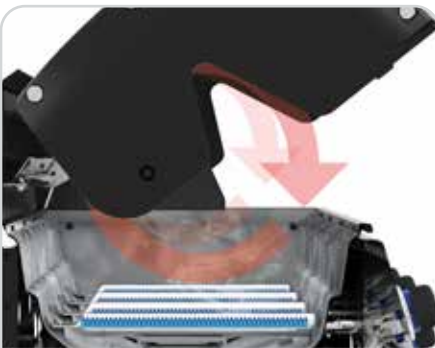

Painted Steel Side Shelves



Tool Hooks



Durable Resin Wheels and Casters



Slide-Out Drip Tray



Tank Holder



Fold-Down Shelves



180 Degree Control



Electronic Ignition









# GEM™

---

**Performance to fit any budget.** Broil King® has barbecue grills to fit any budget without sacrificing our exceptional quality. It's what sets the Broil King® Gem 310 apart from its rivals. This modern-looking grill features a rust-proof cast aluminum cookbox for great heat retention, powerful side ported dual-flame tube burners for even heat distribution, and Linear-Flow™ valves for precise cooking control.





## Gem™ 310

24,000 BTU Main Burner Output

3 Stainless Steel Tube Burners

Cast Iron Grids

## The Gem™ 310 | Grilling Area



Gem™ 310 | 435 Square Inches Total Grilling Area

Stainless Warming Rack  
135 Square Inches



Cookbox  
Cast Iron Grids - 300 Sq In

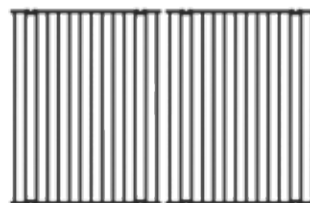



# The Gem™ 310 | Features

Cast Iron Grids



Stainless Steel Tube Burners



Stainless Steel Flav-R-Waves™



Therma Cast™ Aluminum Cookbox

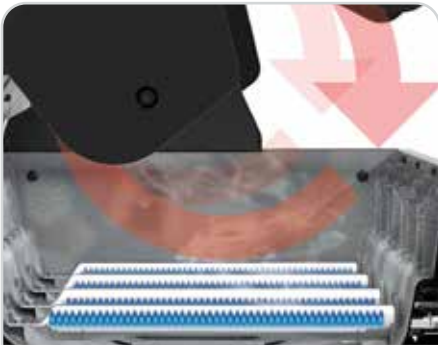

Stainless Steel Lid Handle



Side Shelf Tool Hooks



Durable Resin Wheels



Durable Resin Side Shelves



Tank Holder



Fold-Down Shelves



180 Degree Control



Electronic Ignition









# PORTA-CHEF™

---

**Grilling on-the-go has never been better.** These portable grills come with durable cast aluminum cook boxes to retain heat for even cooking. Whatever model you choose, the Porta-Chef™ series is designed for on-the-go performance and great results.





### Porta-Chef™ 320

24,000 BTU Main Burner Output

3 Stainless Steel Tube Burners

Cast Iron Grids

### Porta-Chef™ 320 Cart

Durable Steel Construction

Two Large Resin Wheels

### Porta-Chef™ 120

14,000 BTU Main Burner Output

1 Stainless Steel Tube Burner

Cast Iron Grid

## The Porta-Chef™ Series | Grilling Area



**Porta-Chef™ 320 | 435 Square Inches Total Grilling Area**

Stainless Warming Rack  
135 Square Inches



Cookbox  
Cast Iron Grid - 300 Sq In

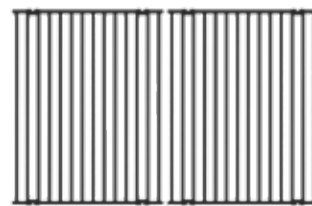

**Porta-Chef™ 120 | 348 Square Inches Total Grilling Area**

Stainless Warming Rack  
128 Square Inches



Cookbox  
Cast Iron Grid - 220 Sq In

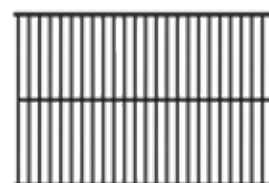



# The Porta-Chef™ Series | Features

Cast Iron Grid(s)



Stainless Steel Tube Burner(s)



Stainless Steel Flav-R-Waves™



Therma Cast™ Aluminum Cookbox

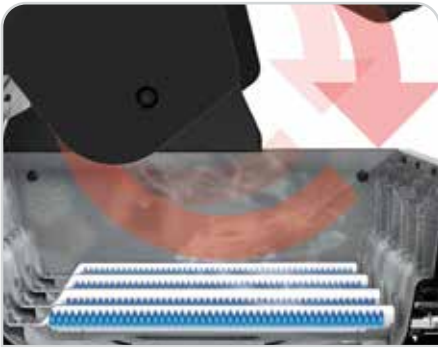

Stainless Steel Lid Handle



Side Shelf Tool Hooks



Durable Resin Cart Wheels



Removable / Snap-In Steel Legs



Cart Tank Holder



Resin Fold-Down Shelves (320)



180 Degree Control



Electronic Ignition







# Oil King®

*"My customers are like family, and I use the best quality meats I can get my hands on. What I use to grill or smoke them isn't any different."* Rob Brady







# KEG

---

**Made for performance and dependability.** Expand your grilling experience and enjoy true cooking performance with authentic barbecue flavor. The patented Broil King® Keg™ is an innovative charcoal grill designed to keep the heat in, creating a very efficient, thermal convection-style oven that delivers superior cooking performance.





## Keg 5000

### 480 Sq-Inches Total Cooking Area

Heavy-Duty Cast Iron Cooking Grids

Insulated Double-Walled Steel Body

Cast Aluminum Roto-Draft™ Damper

Heavy-Duty Cast Iron Damper

## The Keg 5000 | Grilling Area



Keg 5000 | 480 Square Inches Total Grilling Area

Chrome Warming Rack  
200 Square Inches



Cookbox  
Cast Iron Grid - 280 Sq In





# The Keg 5000 | Features

Heavy-Duty Cast Iron Grid



Double-Wall Steel Construction



Cast Iron Roto-Draft™ Damper



Roto-Draft™ Damper



Removable Ash Container



Swing-Out Chrome Warming Rack



Removable Side Shelves



Steel Base with Durable Wheels



Latch and Lock System



Durable Resin Handles



Integrated Tool-Hooks



Trailer Hitch Compatible









# PELLET

**Sear, smoke and roast with the simple touch of a dial.** Smoke brisket or ribs, bake a pizza, sear steak to perfection, rotisserie-cook your favorite roast, and everything in between. Fueled by 100% natural wood pellets, your food gets infused with great smoky flavor. The easy-to-use **iQue™** digital control display will maintain the temperature from low-and-slow 225°F to a searing 600°F. Constructed with heavy-gauge steel, these durable performance grills are built to last. Introducing our premium line of Broil King® Pellet grills: designed for ultimate cooking versatility and great flavor.



# Ultimate Control | The Digital Display

## Three Convenient Quick-Set Buttons



 **Smoke**  
225°F



 **Roast**  
350°F



 **Grill**  
600°F







### iQue™ Wireless Control

Download the free BK App and control what you're grilling.

## Easy Set-Up

### Pairing Your Device with Your Grill



### Infrared Fuel Sensor

Alerts the pellet digital control panel and the pellet app once pellets fall below the fuel sensor. *(available on Pellet Pro series)*



### iQue™ Temperature Control

Dial, push or wirelessly set the exact temperature for consistent cooking results.



### Timer and Stopwatch

Program and set the timer for the perfect doneness.



### Two Deluxe Meat Probes

Monitor the internal temperature of your food on the grill and now on the rotisserie - yes you can!

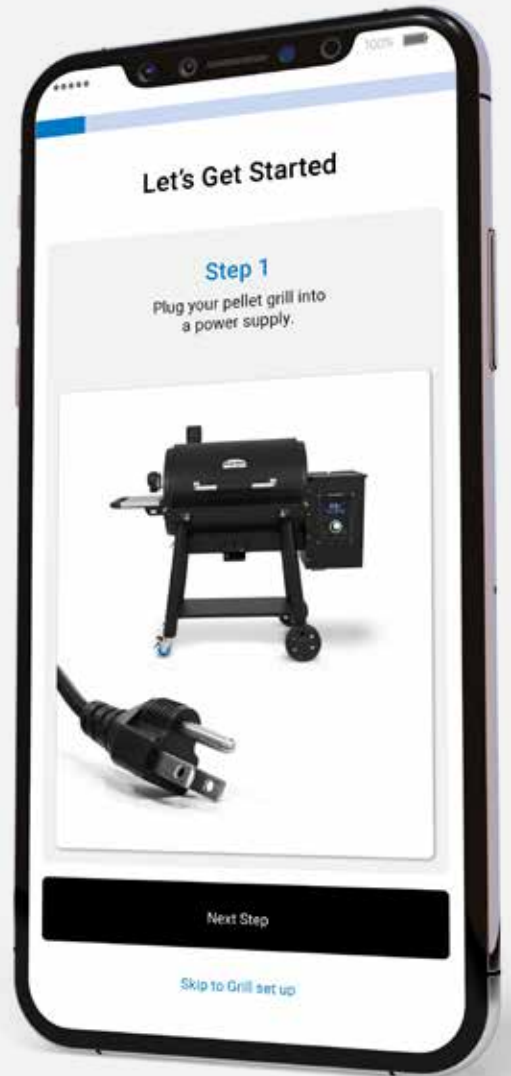



### Regal™ Pellet 500 Pro

865 Sq-Inches Total Cooking Area

9 mm Stainless Steel Grids

Durable Steel Fold-Down Shelf

Infrared Fuel Sensor



### Regal™ Pellet 500

865 Sq-Inches Total Cooking Area

Heavy-Duty Cast Iron Grids



### Crown™ Pellet 500

800 Sq-Inches Total Cooking Area

Heavy-Duty Cast Iron Grids



### Crown™ Pellet 400

640 Sq-Inches Total Cooking Area

Heavy-Duty Cast Iron Grids





## Regal™ Pellet 400

690 Sq-Inches Total Cooking Area

Heavy-Duty Cast Iron Grids



# The Pellet Series | Grilling Area



Regal™ Pellet 500 Pro | 865 Square Inches Total Grilling Area

Stainless Warming Rack  
240 Square Inches

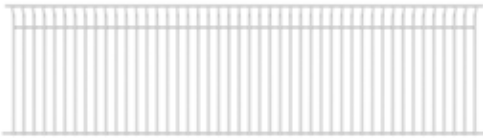

Cookbox  
Stainless Grids - 625 Sq In

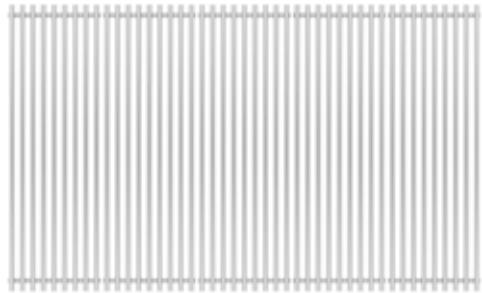

Regal™ Pellet 500 | 865 Square Inches Total Grilling Area

Porcelain-Coated Warming Rack  
240 Square Inches



Cookbox  
Cast Iron Grids - 625 Sq In

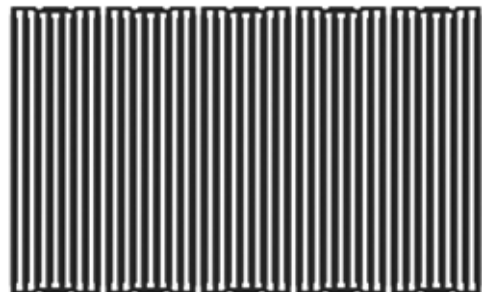



# The Pellet Series | Grilling Area



**Regal™ Pellet 400 | 690 Square Inches Total Grilling Area**

Porcelain-Coated Warming Rack  
190 Square Inches



Cookbox  
Cast Iron Grids - 500 Sq In

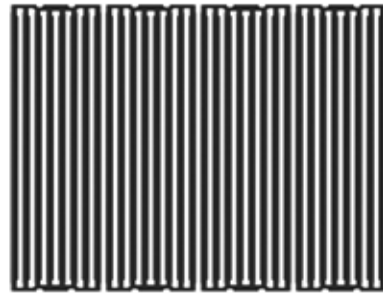

**Crown™ Pellet 500 | 800 Square Inches Total Grilling Area**

Porcelain-Coated Warming Rack  
240 Square Inches



Cookbox  
Cast Iron Grids - 560 Sq In

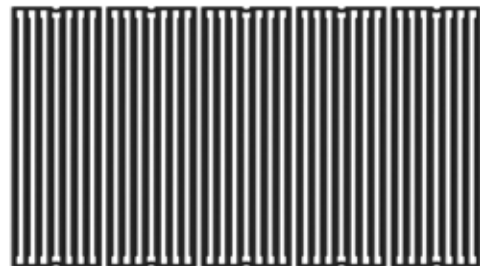

**Crown™ Pellet 400 | 640 Square Inches Total Grilling Area**

Porcelain-Coated Warming Rack  
190 Square Inches



Cookbox  
Cast Iron Grids - 450 Sq In

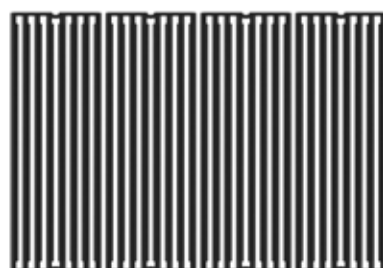

# Redefining Pellet Grilling | Features

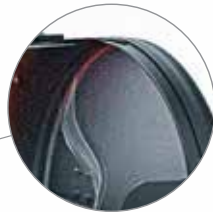

**Extra Heavy-Duty Construction**  
Thick gauge steel and double walled lid retain the heat for even and efficient cooking.



**Extra Thick Cast Iron Grids**  
Retains the heat for steakhouse sear marks.



**Durable Auger with Powerful Motor**  
Automatically feeds pellets from the hopper to the fire chamber for precise heat control.

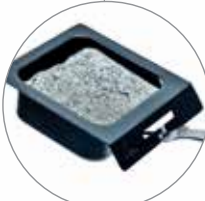

**Removable Ash Tray**  
Conveniently lifts out for easy clean up.



**Burn Pot Agitator**  
Quickly sifts ash into the ash tray.



**Extra Wide Stainless Burn Pot**  
Handles large amounts of pellets to create searing temperatures.



# The Pellet Series | Features

Stainless Steel Grids (Pro)



Stainless Steel Warming Rack (Pro)



Rotisserie Spit and Motor (Regal)



iQue™ Digital Control Center



Two Deluxe Meat Probes

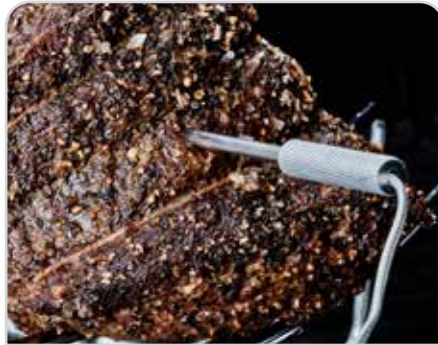

Powerful Heat Induction Fan

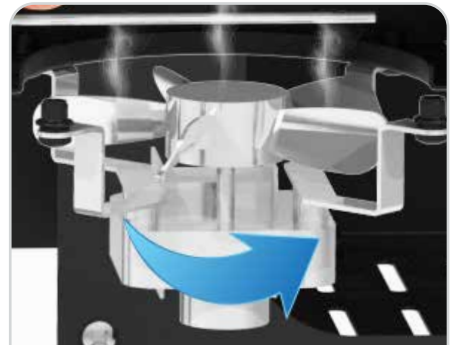

Large Pellet Hopper



Steel Fold-Down Front Shelf (Pro)



Removable Drip Tray



Leveling Feet



Commercial Locking Casters (Pro)



Large Durable Resin Wheels









# CHARCOAL

---

**A must-have for the aspiring pit master.** Styled after traditional southern smokers, these barrel smokers and grills are exceptionally well-crafted. Thick 2mm/14 gauge steel retains heat for precise temperature control. The Smoke offset and grills are must-haves for aspiring pit masters who enjoy authentic, smokehouse grilling.





### Regal™ Offset 500

1,040 Sq-Inches Total Cooking Area

Heavy Cast Iron Cooking Grids

14 Gauge Steel Construction

Removable Steel Shelf



### Regal™ Offset 400

865 Sq-Inches Total Cooking Area

Heavy Cast Iron Cooking Grids

14 Gauge Steel Construction

Removable Steel Shelf



### Regal™ Charcoal 500

865 Sq-Inches Total Cooking Area

Heavy Cast Iron Cooking Grids

14 Gauge Steel Construction

Removable Steel Shelf



### Regal™ Charcoal 400

690 Sq-Inches Total Cooking Area

Heavy Cast Iron Cooking Grids

14 Gauge Steel Construction

Removable Steel Shelf



# The Charcoal Offset Series | Grilling Area



**Regal™ Offset 500 | 1,040 Square Inches Total Grilling Area**

**Stainless Warming Rack**  
240 Square Inches



**Offset**  
Cast Iron Grid - 175 Sq In

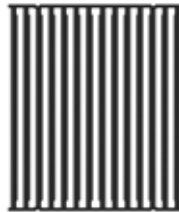

**Cookbox**  
Cast Iron Grids - 625 Sq In

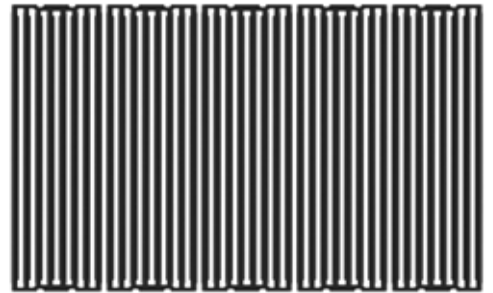

**Regal™ Offset 400 | 865 Square Inches Total Grilling Area**

**Porcelain-Coated Warming Rack**  
190 Square Inches



**Offset**  
Cast Iron Grid - 175 Sq In

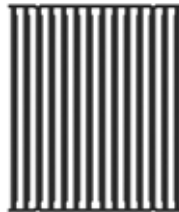

**Cookbox**  
Cast Iron Grids - 500 Sq In

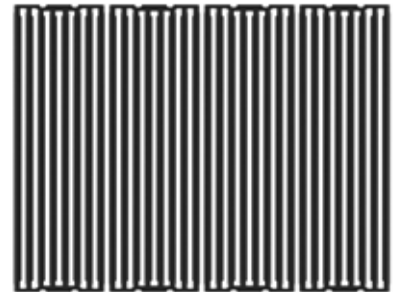

# The Charcoal Grill Series | Grilling Area



Regal™ Charcoal 500 | 865 Square Inches Total Grilling Area

Porcelain-Coated Warming Rack  
240 Square Inches



Cookbox  
Cast Iron Grids - 625 Sq In

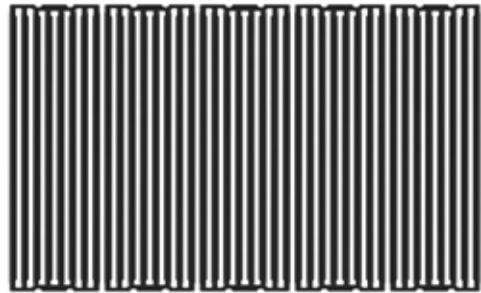

Regal™ Charcoal 400 | 690 Square Inches Total Grilling Area

Porcelain-Coated Warming Rack  
190 Square Inches



Cookbox  
Cast Iron Grids - 500 Sq In

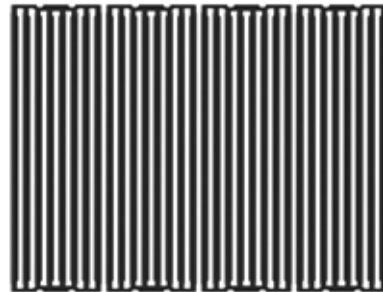

## Direct Grilling

Fill the trays with charcoal to create a direct heat source for grilling steak, chicken and vegetables.



## Indirect Grilling

Fill the small chamber with charcoal and wood to smoke meat like ribs, brisket and pulled pork.





# The Charcoal Series | Features

Cast Iron Grids



Heavy-Duty Construction



Roto-Draft™ Dampers



Offset Chamber



Easy-Access Charcoal Trays



Removable Steel Shelf



Accessory Hooks



Two Stainless Steel Ash Trays



Premium Thermometer



Large Crack-Proof Wheels



Durable Steel Bottom Shelf



Bottle Opener







# SMOKE

---

**Crafted and designed for the weekend griller.** These smokers feature a double-walled body and doors for superior heat control and long lasting durability. Cast aluminum Roto-Draft™ dampers regulate the temperature for exceptional results. Four stainless steel racks provide lots of room for ribs, fish, poultry or anything you want to smoke. Available in propane, natural gas or charcoal, Broil King® Smoke cabinet smokers are engineered for amazing results.





### Smoke Cabinet Propane

15,000 BTU Burner Output

Four Stainless Steel Grids

Stainless Steel Burner

770 Total Cooking Area

### Smoke Cabinet Charcoal

Large Stainless Charcoal Tray

Four Stainless Steel Grids

Large Stainless Water Pan

770 Total Cooking Area

## The Smoke Cabinet Series | Grilling Area



Smoke Cabinet | 770 Square Inches Total Grilling Area

Cookbox  
Stainless Grids - 770 Sq In

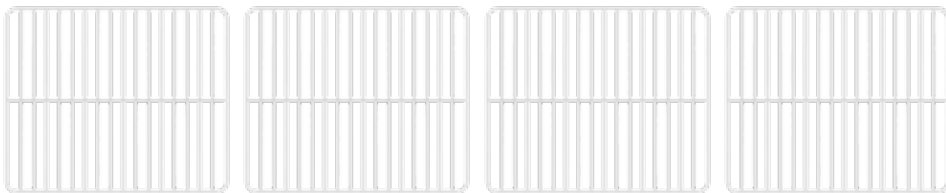

Rib and Roast Rack  
Stainless Steel





# The Smoke Cabinet Series | Features

Stainless Steel Grids



Stainless Steel Burner



Durable Steel Construction



180 Degree Control



Electronic Ignition



Integrated Tool Hooks



Roto-Draft™ Dampers



Fold-Down Drip Tray



Stainless Steel Water Pan



Heavy-Duty Charcoal Tray



Leg Levelers and Wheels



Adjustable Latch System



# 1. UTILIZE YOUR SPACE

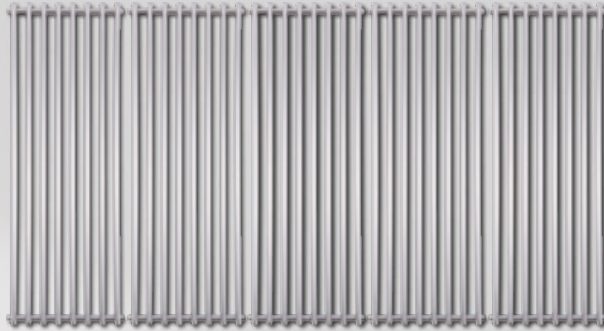

# 2. ADD ACCESSORIES



# 3. BREAKFAST ANYONE?





# DO MORE

**Plan entire meals and grill them on your Broil King® grill.** Yes, you can do that and more with our premium line of space saving grilling accessories. They've been carefully designed and engineered to be used this way. One grill, hundreds of possibilities. It's your grilling space, so go ahead and use it to its fullest. Our premium grilling accessories will transform your grill into the ultimate entertaining appliance. From everyday essentials to sought-after specialties, Broil King® has whatever you need.



# Space-Saving Accessories | On-Grill



## 69122 Narrow Griddle

Stainless steel 3-sided griddle

Easy to clean and perfect for searing

Designed to save space

15-in x 6.875-in x 1-in

## 69138 Narrow Kebab Rack

Holds 4 dual-prong skewers at a time

Dual prongs prevent foods from spinning

12-in / 30.5 cm skewers

12-in x 8-in x 2.15-in



## 69822 Narrow Wok

Made from durable stainless steel

Fits front to back on all Broil King® grills

Creates shaker basket with (#69722)

14.5-in x 6.5-in x 3.5-in

## 69722 Narrow Topper

Made from durable stainless steel

Fits front to back on all Broil King® grills

Creates shaker basket with (#69822)

14.5-in x 6.5-in x 3.5-in



## 63280 Cedar Grilling Planks

100% natural cedar

Two grilling planks - 1/4-in (1cm) thick

Designed to save space

7.5-in x 15-in

## 63290 Maple Grilling Planks

100% natural maple

Two grilling planks - 1/4-in (1cm) thick

Designed to save space

7.5-in x 15-in



# Space-Saving Accessories | In-Grill



## Exact-Fit Cast Iron Woks

Built specifically to fit front to back on a Broil King® grills

Thick and heavy porcelain coated cast iron retains heat for amazing results

## Exact-Fit Cast Iron Griddle

Reversible: smooth side for frying, ribbed for searing

Thick and heavy porcelain-coated cast iron retains heat for amazing results

|       |                         |
|-------|-------------------------|
| 69618 | Imperial™/Regal™ Series |
|-------|-------------------------|

|       |                      |
|-------|----------------------|
| 69617 | Baron™/Crown™ Series |
|-------|----------------------|

|       |                           |
|-------|---------------------------|
| 11239 | Imperial™ 600, 500 Series |
|-------|---------------------------|

|       |                             |
|-------|-----------------------------|
| 11239 | Regal™ 600, 500, 400 Series |
|-------|-----------------------------|

|       |                             |
|-------|-----------------------------|
| 11242 | Baron™ 500, 400, 300 Series |
|-------|-----------------------------|

|       |                   |
|-------|-------------------|
| 11242 | Crown™ 400 Series |
|-------|-------------------|

|       |                  |
|-------|------------------|
| 11221 | Signet™ 390, 320 |
|-------|------------------|

|       |                        |
|-------|------------------------|
| 11223 | Monarch™ 390, 340, 320 |
|-------|------------------------|

|       |                            |
|-------|----------------------------|
| 11237 | Porta-Chef™ 320   Gem™ 310 |
|-------|----------------------------|

|       |                            |
|-------|----------------------------|
| 11239 | Regal™ Pellet/Smoke Series |
|-------|----------------------------|

|       |                      |
|-------|----------------------|
| 11242 | Crown™ Pellet Series |
|-------|----------------------|

|       |                          |
|-------|--------------------------|
| 11250 | Models with Side Burners |
|-------|--------------------------|



Stack two cast iron woks to create a roaster / Dutch oven.



## 11250 Side Burner Griddle

Cast iron with matte porcelain coating

Made for Broil King® grills with rectangular trivet

Reversible with smooth and ribbed sides

12.25-in x 10.5-in



## Do More | Featured New Items



### 69842 Rectangular Pizza Stone

Exact fit pizza stone occupies space of 2 Baron™ cooking grids

Reversible stone holds heat to quickly cook pizzas on the grill

Exact fit: Baron™ Series, Crown™ Series, Crown™ Pellet Series

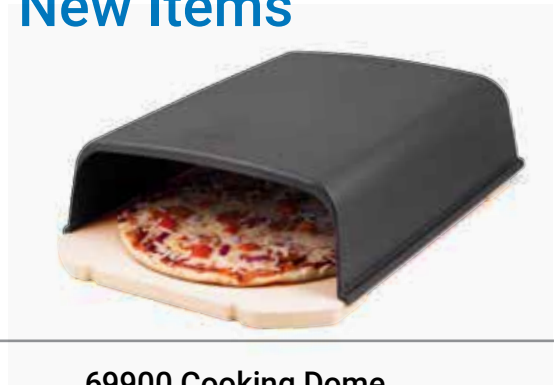

### 69900 Cooking Dome

Perfect for crisping pizza or melting cheese

Integrates with 69842 Rectangular Pizza Stone, 11342 Plancha or 11242 Cast Iron Griddle to direct heat downwards

Exact fit: Baron™ Series, Crown™ Series, Crown™ Pellet Series



### 69810 Pizza Cutter

Deluxe pizza wheel slices up fresh and hot grilled pizza in no time

Contoured handle for secure grip



### 68422 Wood Fiber Cutting Board

Double sided wood fiber cutting board with moat for carving and serving

Rubber feet keep board from sliding while carving

Easy to clean and dishwasher safe



### 11342 Cast Iron Plancha

Exact fit plancha occupies space of 2 Baron™ cooking grids

Heavy cast iron and coated with durable matte porcelain finish

Front trough collects excess grease



### 64039 Plancha Scraper

Contoured sides to easily clean grease trough of Broil King® plancha

Stainless steel blade easily scrapes away charred bits

Hard resin handle embossed with Broil King® logo



## Do More | Featured New Items



### 63110 Stack-A-Rack

Multi-purpose rack designed to elevate foods and create more cooking space

Notched feet are designed to rest on grid tines and stack

Designed to fit inside 63106 stainless roasting pan



### 69610 Cast Iron Multi Roaster

Heavy cast iron and coated with durable matte porcelain finish

Retains heat for long consistent cook

Internal stainless roasting rack elevates cuts of meat

12-IN x 16-IN of usable cooking space



### 64939 Carving Knife

18-in brisket knife designed specifically for slicing large cuts of meat

Produces even, smooth cuts

Perfect for brisket, ham and other large cuts of meat



### 62475 Deluxe Burger Press

Perfectly presses a fresh 4,5 or 6 oz. burger

Dimpled burger shape prevents swelling and maintains shape through grilling

Easy to clean

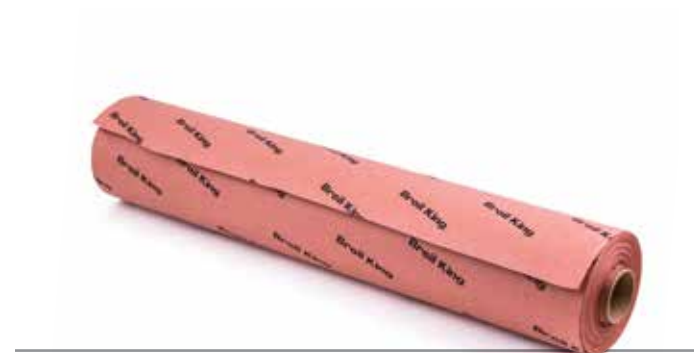

### 69600 Butcher Paper

150-ft roll of premium butcher paper

Perfect for wrapping brisket or other smoked meats to retain moisture

17.75-in x 150-ft



### 64006 Wine Bottle Opener

Thick stainless steel handle design makes this a "must have" for the ultimate griller

Includes corkscrew, foil cutter and two-stage opener with bottle cap opener

## Cook More | Woks & Toppers



### 69720 Grill Topper

Stainless steel grilling topper

Stainless handles and raised contours

Large, perforated, rigid contoured surface

18.6-in x 11.5-in



### 69820 Grilling Wok

Stainless steel grilling wok

Stainless handles and raised contours

Rounded corners, rigid perforated surface

15.2-in x 12.8-in x 3-in



### 69712 Flat Topper

High grade 1.2 mm stainless steel

Large design gives you more cooking space

Oversized handles, raised square perforations

12.8-in x 18.8-in x 2.1-in



### 69818 Deep Dish Grilling Wok

High grade 1.2 mm stainless steel

Large deep design offers more cooking space

Raised perforations keep food from sticking

16.6-in x 9.8-in x 3.2-in



### 69710 Cast Grilling Wok

Porcelain-coated heavy cast iron

Easy to clean, great heat retention

Delivers constant searing

14-in Diameter | 3.75-in Depth



### 69819 Roasting Basket

Stainless steel roasting basket

Micro-perforated for smooth roasting surface

Roast small items easily

17.2-in x 10.9-in x 4.1-in



## Create More | Skewers & Racks



### 64233 Multi Rack & Skewer Kit

6 stainless steel dual-prong skewers

Skewers rest on the rack for elevated cooking

Reversible rib/roast rack

15.3-in x 13.8-in x 3.7-in



### 64049 Grilling Skewers

4 stainless steel dual-prong skewers

Durable 3 mm stainless steel wire

Easy to clean

12-in

## Bake More | Pizza Gear



### 69814 Oversized Pizza Stone

Extra-thick 3/4-in (1.9 cm) ceramic stone

The extra-thick stone provides more even heat

Resists moisture or temperature-related cracking

15-in Diameter



### 69800 Stainless Pizza Peel

Stainless steel

Folding soft-grip handle, large blade

Easy to clean

25.5-in x 10.8-in



### 69816 Stone Grill Set

High-grade 1.2 mm stainless steel cradle

Includes a reversible, resilient 13-in pizza stone

Large 29.8-in x 13.2-in wood pizza peel

15.8-in x 13.3-in x 2-in



# Roast More | Roasters & Racks



## 64152 Wing Rack

Includes a stainless steel pan and wing rack  
Great for hanging wings, thighs and drumsticks  
Folding wing rack for easy storage  
15-in x 7-in x 5.6-in



## 62602 Rib Rack and Roast Support

Stainless steel construction, 10 mm and 5 mm  
Accommodates up to 7 racks of ribs  
Supports roasts as well  
15.2-in x 8.6-in x 4-in



## 65070 Premium Grill Basket

Stainless steel wire with soft resin handle  
Multi-position lid and detachable handle  
Simple to use locking mechanism  
22.1-in x 12.4-in x 2.5-in



## 63106 Roasting Pan

Stainless steel  
Use as drip pan, marinating dish or serving tray  
Features integrated stainless handles  
13.25-in x 10.5-in x 1.5-in



## 69133 Chicken Roaster with Pan

Heavy stainless steel with oversized handles  
Enough capacity to hold an entire beer can  
Vented at the top for better steaming action  
13.3-in x 9.2-in x 4.8-in



## 69132 Chicken Roaster

Stainless steel supports and pan  
Supports secure a beverage can  
Silicone bezel thermometer included  
7-in x 8.2-in



## Roast More | Roasters & Racks



### 69615 Cast Rib Roaster

Thick porcelain coated cast iron retains heat

Dimpled lid bastes food

Roasting rack elevate ribs off the bottom

17.6-in x 7-in x 7-in



### 69616 Foil Rib Roaster

Thick reusable foil with dimpled lid to baste food

Designed to keep ribs off the bottom of pan

Use with or without 69615 Cast Rib Roaster

18.1-in x 7.6-in x 6.3-in



# Enjoy More | The Essentials



## 60975 Grilling Apron

Easy to clean water-resistant PVC exterior

Five convenient pockets for lots of grilling essentials

Includes bottle opener

Adjustable neck strap with buckle mechanism



## 68429 Imperial™ Cutting/Serving Board

Bamboo cutting/serving board

For cooked meats or vegetable prep

Large moat to trap drippings

17.75-in x 12.25-in



## 68428 Baron™ Cutting/Serving Board

Bamboo cutting/serving board

For cooked meats or vegetable prep

Moat to trap drippings

15.5-IN x 10-IN



## Enjoy More | The Essentials



### 61935 Side Table Thermometer

Back-lit screen with integrated countdown timer

Reads two temperatures at one time

Includes two meat probes

5-in



### 61825 Instant Read Thermometer

Quick temperature level readouts

Compact and reliable with back-lit screen

Protective sheath included

8-in



### 60974 Insulated Mitt

Heat-resistant aramid exterior with silicone grip

5 independent digits offer great dexterity

Long cuff design and easy to clean

One size fits most, one mitt



### 60528 Leather Grilling Gloves

Heavy-duty leather grilling gloves

5 independent digits offer great dexterity

Extra soft linings

One size fits most, set of two gloves



### 61900 Two-Piece Thermometer Probes

Upgraded thermometer probes for pellet series grills

Colored tips for easily identifying probes

Fits Regal™ pellet series, Crown™ pellet series

4-ft wire



### 61138 Mini Thermometers

4 pack of mini meat thermometers

Silicone bezels for easy removal

Calibrated for poultry in red and steak in black

2.5-in

## Enjoy More | The Essentials



### 60007 Regal™ Silicone Side Shelf Mat

Protects your grill from grease or sauce

Prevent scratches on stainless or painted shelves

Magnets keep mat attached to hopper lid

13.75-in x 10.75-in



### 60008 Baron™ Silicone Side Shelf Mat

Protects your grill from grease or sauce

Prevent scratches on stainless or painted shelves

Magnets keep mat attached to hopper lid

13.75-in x 8.5-in



### 60009 Silicone Side Shelf Mat

Protects your grill from grease or sauce

Prevent scratches on stainless or painted shelves

Easy to clean, dishwasher safe

13.75-in x 10.75-in



### 61495 Marinade Injector

Stainless steel body and tips

Includes diffuser and injector needles

Easily monitor amount of marinade being injected

1.5-oz | 44 ml capacity



### 61490 Stainless Basting Set

Stainless steel, silicone, resin handles

Silicone brush head heat resistant to 500°F | 260°C

This set includes a 300ml / 1.25 cup bowl

Brush: 10-in, Bowl: 300 ml, Handle: 3.9-in



### 60945 Oil Spritzer

Multi-functional, non-aerosol mist spritzer

Spritzer does not require pumping or priming

Viewing lets you easily monitor fill level

7-in x 2-in



# Enjoy More | The Essentials



## 60934 Handle Mount (Flex-Strap) Light

Resin body with elastomer band

Dual COB light strips

Elastomer band fits any Broil King® handle

5-in



## 60936 Handle Mount (Slide-On) Light

Resin mount with detachable slide on grill light

Dual COB light strips

Fits on 32 mm round Broil King® handles

5-in



## 60938 Deluxe Light and Timer

Two ultra-bright cob light strips

Light up your entire grilling surface

Back lit LCD display with integrated steak timer

10-in



## 990616 Broil King® Tumbler

Stainless steel tumbler

Slide lock spill-resistant resin lid

Black grip material on the tumbler body

20-oz (591 ml) capacity



## 60745 Grid Lifter

Removes both cast and stainless cooking grids

Stainless tip and resin handle

Integrates with many Broil King® accessories

10.75-in



## 64009 Broil King® Bottle Opener

Stainless steel with resin handle

Styled after our popular Imperial™ grill turner

Compact, durable bottle opening tool

4.7-in

# Enjoy More | The Essentials



## 60669 Pellet / Charcoal Rotisserie Kit

Chrome plated steel

Heavy duty spit forks, counter balancing kit, spit rod

OEM and universal mounting hardware

33-in with 6-in optional extension



## 66009 Universal Rotisserie Kit

Chrome plated steel

Heavy duty spit forks, counter balancing kit, spit rod

OEM and universal mounting hardware

33-in with 6-in optional extension



## 50502 Stainless Meat Forks

Heavy duty nickel chrome plated

For 3/8-in rod

Four prongs secure the food - Set of two

4-in



## 50500 Stainless Mega Forks

6 C-shaped forks - 4 square and 2 tapered

Splined to lock into multiple positions

Disassembles for easy cleanup

5-in



## 64075 Meat Shredder Tool

Stainless steel fork and shaft

Attaches to drill for easy shredding of meat

Disassembles for easy cleaning

13-in shaft, 5-in forks



## 64875 Rotisserie Tumble Basket

Fits on rotisserie rod, perforated stainless steel

Use as a tumbling basket for small food items

Basket can be separated and used as wok

15-in x 7-in





# Grill More | Tools of the Trade



## 64003 Baron™ Grill Tool Set

Durable resin handles with stainless steel blades  
Turner, tongs, basting brush and palmyra grill brush  
Additional palmyra heads available (#64658)  
4 piece tool set



## 64001 Porta-Chef™ Tool Kit

Turner, tongs, basting brush and palmyra grill brush  
8-in chef's knife with knife guard  
Reversible cutting board lid, silicone locking straps  
7 piece tool set



## 64312 Grill Tongs - 3 Pack

Stainless steel, colored rubber inserts  
Colors avoid cross contamination between foods  
Red (meat), green (vegetables), blue (fish/seafood)  
3 piece tool set



## 64103 Imperial™ Tool Set

Premium tool set with turner, tong and basting brush  
Large resin handles with contrasting undermount grips  
Durable box shaped shafts and hanging hooks  
3 piece tool set



## 64011 Imperial™ Turner

High grade 1.8 mm stainless steel  
High density resin handle  
Features an integrated bottle opener  
18-in



## 64110 Imperial™ Super Flipper

Premium extra large super flipper  
Large resin handle with contrasting undermount grip  
Durable box shaped shaft and hanging hook  
19-in

## Enjoy More | The Essentials



### 64031 Baron™ Turner

Stainless steel, resin handle

Flexible blade allows it to scoop up items easily

Box design shaft gives it strength and rigidity

17.5-in



### 64030 Baron™ Super Flipper

Stainless steel, resin handle

Extra long blade

Flexible blade allows it to scoop up items easily

17.5-in



### 64112 Imperial™ Tongs

Premium tongs featuring flat and scalloped sides

Large resin handle with contrasting undermount grip

The locking mechanism doubles as hanging hook

19-in



### 64032 Baron™ Tongs

Stainless steel, soft grips

One spatula blade tip, one tong tip, locking tab

The locking mechanism doubles as hanging hook

17.7-in



### 64036 Baron™ 12-IN Precision Tongs

Stainless steel, soft grips

Scalloped tong tips, locking tab

Precision end for a variety of foods

12-in



### 64935 Steak Knives

Crafted from hard 420 j2 stainless steel

Heavy resin handles

Set of 4 stainless steel steak knives

9.6-in

# Smoke More | It's All About Flavor



## 60190 Premium Smoker Box

Designed to sit on Flav-R-Wave™ or cooking grids

Two chambers for twice the smoking power

Integrated sliding air damper

14.13-in x 5.10-in x 1.90-in



## 60181 Pellet Smoker Box

Designed to sit on Flav-R-Wave™ or cooking grids

Stainless steel, for use with Broil King® pellets

Add pellet smoke flavor to gas-grilled foods

13-in x 2.7-in x 1.5-in



## 60185 Smoker Box

Stainless steel smoker box

With handles and a hinged lid

Add smoke flavor to gas grills

11.6-in x 3.2-in x 1.3-in



## 63200 Mesquite Wood Chips

Add bold wood-smoked flavor to grilled foods

Use with a smoker box or add directly to charcoal

Try with beef, pork, poultry

170 cubic inches of chips per box



## 63220 Hickory Wood Chips

Add iconic wood-smoked flavor to grilled foods

Use with a smoker box or add directly to charcoal

Try with beef, pork, poultry, and fish

170 cubic inches of chips per box



## 63230 Apple Wood Chips

Add sweet wood-smoked flavor to grilled foods

Use with a smoker box or add directly to charcoal

Try with beef, pork, poultry, and fish

170 cubic inches of chips per box



# Pellet More | Better Fuel for Better Flavor



## 63930 Smoke Master's Blend

A blend of maple, hickory and cherry

Adds a well-balanced smoke flavor to grilled foods

100% natural with no fillers, binders or additives

20 lb bag with zipper seal

## 63939 Griller's Select Blend

A blend of maple, oak and cherry

A great choice as an everyday grilling pellet

100% natural with no fillers, binders or additives

20 lb bag with zipper seal

The perfect barbecue starts with the right kind of fuel.

Broil King's Premium Grilling Pellets are specifically designed to work with the Broil King® Pellet series grills.



## 63920 Hickory

Hickory offers a strong smoke taste

Often associated with bacon or smoked ham

100% natural with no fillers, binders or additives

20 lb bag with zipper seal



## Smoke Master's Blend Maple | Hickory | Cherry

A selection of pellets popular with competition BBQ champions. This blend offers hints of sweetness combined with a full bodied hickory smoke. Adds a well-balanced smoke taste to grilled foods. Try with beef, poultry and pork.

## Griller's Select Blend Maple | Oak | Cherry

This pellet blend offers a lighter and slightly sweet smoke, designed to not over-power natural flavors. A great choice as an everyday grilling pellet. Try with beef, poultry, pork, fish, vegetables and pizza.

# Pellet More | Better Fuel for Better Flavor



## 63923 Apple Blend

A blend of apple and oak

Adds a sweet smoke flavor to grilled foods

100% natural with no fillers, binders or additives

20 lb bag with zipper seal



## 63921 Mesquite Blend

A blend of mesquite and oak

Adds a traditional South-West smoke flavor

100% natural with no fillers, binders or additives

20 lb bag with zipper seal



## 66900 Pellet Storage Bin

Durable resin construction

Perfectly holds one 20lb bag of Broil King® Pellets

Convenient flip-up spout to fill the hopper

13.75-in x 16.625-in x 6-in

## 63946 Pellet Scoop

Stainless steel, resin handle

Graduated scoop base

Integrated sifter removes dust

14-in x 4.8-in

### Hickory 100% Hickory

The most iconic BBQ flavor. Hickory offers a strong smoke taste, often associated with bacon or smoked ham. This robust smoke works well with large cuts of meats. Try with beef, poultry, pork and hearty vegetables.

### Mesquite Blend Mesquite | Oak

Experience southern smokehouse aroma with spicy and tangy undertones. Mesquite pellets add exceptional flavor to whatever you throw on your grill. Try with beef, wild game, lamb and pork.

### Apple Blend Apple | Oak

A selection of pellets popular with competition BBQ champions. This blend offers hints of sweetness combined with a full bodied hickory smoke. Adds a well-balanced smoke taste to grilled foods. Try with beef, poultry and pork.

# Preserve More | Keep Your Grill Clean



## 65641 Extra Wide Stainless Brush

Large stainless steel twisted bristle head

Cleans deep into the corners of the grill

Cleans deep between grids

18-in x 6.5-in



## 65648 Extra Wide Palmyra Brush

Palmyra wood fiber twisted bristle head

Cleans deep into the corners of the grill

Cleans deep between grids

18-in x 6.5-in



## 65229 Heavy-Duty Stainless Brush

Extra heavy and extra long stainless bristles

Patented grime guard flap

Integrated wood scraper

20-in



## 65228 Heavy-Duty Palmyra Brush

Extra heavy and extra long palmyra bristles

Patented grime guard flap

Integrated wood scraper

20-in



## 65900 Pellet Grill Cleaning Kit

Includes dust pan, sweeping brush and 2 scrapers

Wide scraper easily removes baked-on food residue

The narrow scraper gets into smaller areas

4 piece maintenance set



## 64310 Venturi Brush Kit

Stainless bristles, scraper & venturi shaft

Resin body / handle with fine tip venturi brush

Needle tip to clean out clogged burner tube holes

2 piece maintenance set



# Grill More | Tools of the Trade

FOR USE ON COLD GRILL



## 65641 Extra Wide Nylon Brush

Stiff nylon twisted bristle head

Cleans deep into the corners of the grill

Cleans deep between grids

18-in x 6.5-in



## 65335 Wood Grill Scraper

Wooden grill scraper with power grip

Strips tough sticky grime or charred bits away

Use on cast iron, cast stainless or stainless rod grids

18-in

FOR USE ON WARM GRILL



## 64038 Baron™ Palmyra Brush

All-natural palmyra bristles offer a stiff texture

1.2 mm stainless steel, durable resin handle

Includes 2 replacement heads

17.6-in x 3-in



## 65679 Deluxe Ice Brush & Ice Tray

Cleans around the grids as it melts

Leaves no residue

Ice cartridges easily clip onto the brush head

17.6-in x 3-in | 44.7 cm x 7.6 cm

FOR USE ON WARM GRILL



## 64658 Baron™ Palmyra Brush Heads

All-natural palmyra bristles offer a stiff texture

Any lost bristles will burn on a hot grill

3-Pack replaceable brush heads

3.5-in x 2.25-in



# Preserve More | Keep Your Grill Clean



---

## 62380 Grill and Casting Cleaner

For use on grill and castings

Easily removes grease, grime and smoke stains

Non-aerosol pump spray bottle

24-oz



---

## 62390 Grill Revitalizer

For stainless or porcelain exterior surfaces

Removes the toughest grime, rust and smoke stains

Goes on without water

8-oz



---

## 62385 Stainless Cleaner

Stainless steel cleaner and polish

Lightly cleans and restores stainless steel shine

Non-aerosol pump spray bottle

24-oz

# Kamado More | Keg Accessories



## KA5527 Multi-Purpose Tool

Stainless steel with resin handle

Lift and adjust cooking grids, warming rack, dampers

Clean ash from fire bowl

18-in



## KA5545 Cooking Grate Set

Cast iron primary cooking grate

Chrome wire swing-away warming rack

Added cooking capacity

Grid 18.5-in, Rack 16-in



## 64070 Meat Claws

Hold and pull pork roasts, pot roasts and poultry

Heavy stainless steel wire design with forged handles

Silicone holder/hanging coupler

8.3-in x 2.9-in



## KA5533 Diffuser Kit

Durable porcelain-coated steel

Drip pan, diffuser, elevates the cooking grid

Enhances indirect cooking performance

14.8-in x 8.9-in



## KA3367 Electric Charcoal Starter

Designed specifically for kamado grills

Extra long stainless element

Rapid charcoal ignition

18-in element



## TCF5505 Hardwood Lump Charcoal

Natural hardwood lump charcoal

Authentic flavor and unmatched performance

Contains no chemicals, additives or fillers

8.8 lb bag



# Protect More | Broil King® Grill Covers



## Premium Exact-Fit Covers

Crafted from water-resistant PVC with a heavy woven 900D polyester backing. Premium covers feature mesh venting for enhanced air flow and moisture resistance as well as hook and loop closures for a superior fit. Blue accent stitching adds style to the extra reinforced seams. Molded rubber handles make the cover easy to remove.



|       |                            |
|-------|----------------------------|
| 68490 | Regal™ 690                 |
| 68492 | Regal™ 500 Series          |
| 68491 | Regal™ 400 Series          |
| 68488 | Baron™ 500 Series          |
| 68487 | Baron™ 400 series          |
| 68470 | Baron™ 320                 |
| 68487 | Signet™ 390, 320           |
| 68470 | Monarch™ 390, 340, 320     |
| 67069 | Regal™ Pellet / Offset 500 |
| 67065 | Regal™ Pellet / Offset 400 |

## Select Exact-Fit Covers

Broil King® Select Series covers are crafted from durable and weather-resistant PVC outer shell with a 500 x 300D polyester lining. These deluxe covers feature hook and loop closures, polyester handles, and the Broil King® logo screened onto the front.



|                  |                         |
|------------------|-------------------------|
| 67488            | Baron™ 500 Series       |
| 67487            | Baron™ 400 Series       |
| 67470            | Baron™ 320              |
| 67487            | Signet™ 390, 320        |
| 67470            | Monarch™ 300 Series     |
| <b>NEW</b> 67468 | Gem™ 310 (shelves up)   |
| 67420            | Gem™ 310 (shelves down) |
| 67420            | Porta-Chef™ 320, 120    |
| 67066            | Crown™ Pellet 500       |
| 67064            | Crown™ Pellet 400       |

# Protect More | Broil King® Grill Covers



## KA5535 Keg 5000 Cover

900D polyester fade-resistant PVC exterior with embroidered Broil King® Keg logo and blue accent stitching

Fits Keg 5000 and 4000 with shelves



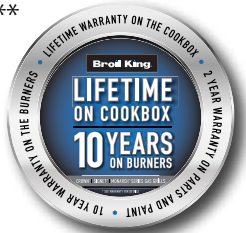

# IMPERIAL™

\*



IMPERIAL® S 690i  
897884 LP / 897887 NG



IMPERIAL® S 590i  
896884 LP / 896887 NG

# REGAL™

\*



REGAL® S 690 PRO IR  
957944 LP / 957947 NG



REGAL® S 590 PRO IR  
958944 LP / 958947 NG



REGAL® S 590 PRO  
958344 LP / 958347 NG

# BARON™

\*



BARON® S 590 PRO IR  
876944 LP / 876947 NG



BARON® S 490 PRO IR  
875944 LP / 875947 NG



BARON® S 440 PRO IR  
875924 LP / 875927 NG

# CROWN™

\*\*



CROWN® S 490  
865384 LP / 865387 NG



CROWN® S 440  
865364 LP / 865367 NG



CROWN® 420  
865254 LP / 865257 NG

# SIGNET™

\*\*



SIGNET® 390  
946884 LP / 946887 NG



SIGNET® 320  
946854 LP / 946857 NG

# MONARCH™

\*\*



MONARCH® 390  
834284 LP / 834287 NG



MONARCH® 340  
834264 LP / 834267 NG



MONARCH® 320  
834254 LP / 834257 NG

# GEM™

\*\*\*



GEM® 310  
814154 LP





REGAL<sup>®</sup> S 490 PRO IR  
956944 LP / 956947 NG



REGAL<sup>®</sup> S 420 PRO  
956314 LP / 956317 NG



BARON<sup>®</sup> 590 PRO  
876244 LP / 876247 NG



BARON<sup>®</sup> 520 PRO  
876214 LP / 876217 NG



BARON<sup>®</sup> 490 PRO  
875244 LP / 875247 NG



BARON<sup>®</sup> 440 PRO  
875224 LP / 875227 NG



BARON<sup>®</sup> 420 PRO  
875214 LP / 875217 NG



BARON<sup>®</sup> 320 PRO  
874214 LP / 874217 NG



CROWN<sup>®</sup> 410  
865054 LP / 865057 NG



CROWN<sup>®</sup> 310  
864054 LP / 864057 NG

# PORTA-CHEF<sup>™</sup>

\*\*\*



PORTA-CHEF<sup>®</sup> 320  
952654 LP



PORTA-CHEF<sup>®</sup> 120  
950654 LP



PORTA-CHEF<sup>®</sup> CART\*\*\*\*\*  
902500

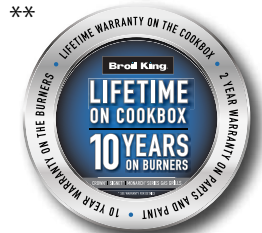

## REGAL™ PELLET

\*\*\*\*\*



REGAL™ PELLET 500 PRO  
496911



REGAL™ PELLET 500  
496051



REGAL™ PELLET 400  
495051

## CROWN™ PELLET

\*\*\*\*\*



CROWN™ PELLET 500  
494051



CROWN™ PELLET 400  
493051

## REGAL™ SMOKE

\*\*\*\*\*



REGAL™ CHARCOAL OFFSET 500  
958050



REGAL™ CHARCOAL OFFSET 400  
955050



REGAL™ CHARCOAL GRILL 500  
948050

## KEG

\*\*\*\*



KEG 5000  
911470

## CABINET

\*\*\*\*\*



SMOKE CABINET CHARCOAL  
923610 CH



SMOKE CABINET GAS  
923614 LP/923617 NG



REGAL™ CHARCOAL GRILL 400  
945050

---





# Broil King® Digital Asset Management System

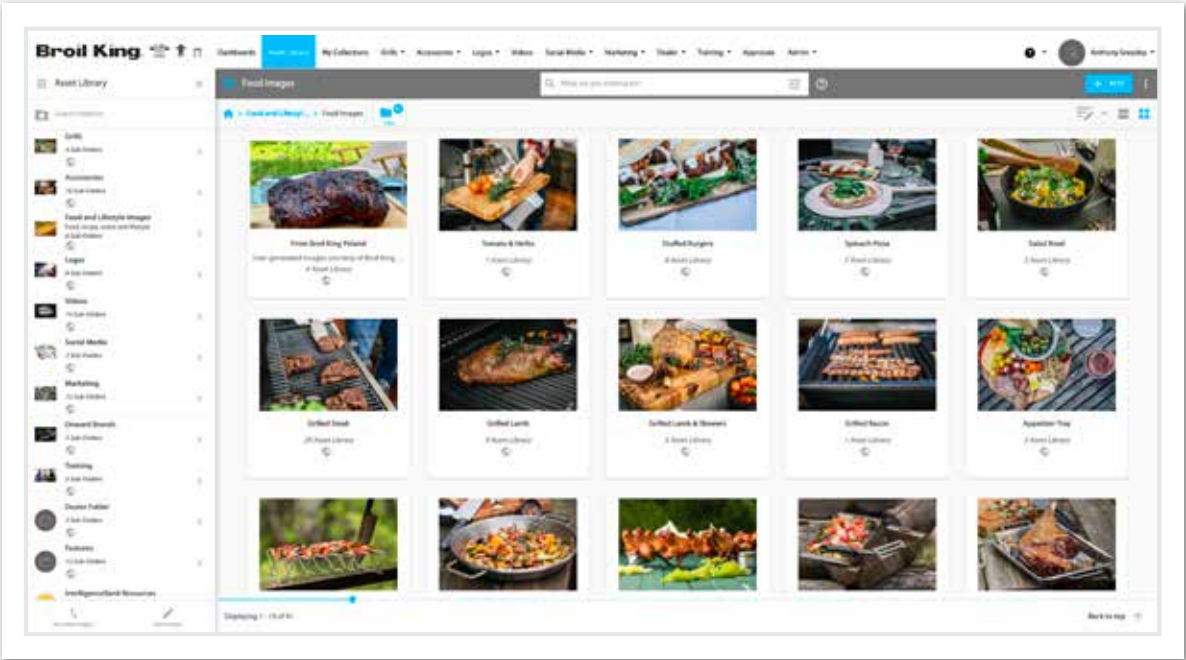

# Broil King® Sales Collateral. Contact your Sales Representative.



**2023 Broil King®  
Booking Program**

**2023 Broil King®  
Price List**

**2023 Broil King®  
Built-In Price List**



**2023 GrillPro®  
Accessories Price List**

**2023 GrillPro®  
Grills Price List**



**2023 Grill Care®  
Price List**

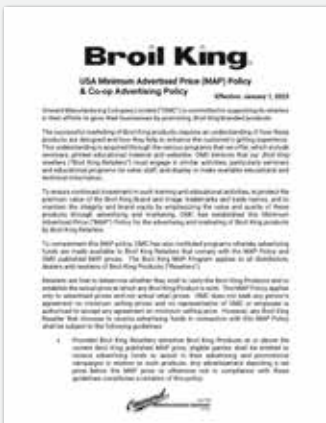

**2023 Broil King®  
MAP & CO-OP Policy**



**Broil King®  
Brand Standards Guide**



**2023 Broil King®  
Town Display Program**

**Broil King**<sup>®</sup>  
Great Barbecues Every Time